



**USAID**  
FROM THE AMERICAN PEOPLE

# IUD Guidelines

*for Family Planning Service Programs*

A Problem-Solving Reference Manual

**editors**

Julia Bluestone  
Rebecca Chase  
Enriquito R. Lu



**JHPIEGO** An Affiliate of  
Johns Hopkins  
University  
A GLOBAL LEADER IN IMPROVING HEALTH CARE FOR WOMEN AND FAMILIES



Third Edition



**USAID**  
FROM THE AMERICAN PEOPLE

# IUD Guidelines

*for Family Planning Service Programs*

A Problem-Solving Reference Manual

editors

Julia Bluestone

Rebecca Chase

Enriquito R. Lu



**J H P I E G O** An Affiliate of  
Johns Hopkins  
University  
A GLOBAL LEADER IN IMPROVING HEALTH CARE FOR WOMEN AND FAMILIES

JHPIEGO, an affiliate of The Johns Hopkins University, builds global and local partnerships to enhance the quality of health care services for women and families around the world. JHPIEGO is a global leader in the creation of innovative and effective approaches to developing human resources for health.

Copyright © 2006 by JHPIEGO. All rights reserved.

Published by:  
JHPIEGO  
Brown's Wharf  
1615 Thames Street  
Baltimore, Maryland 21231-3492, USA  
<http://www.jhpiego.org>

---

The Capacity Project is an innovative global initiative funded by the United States Agency for International Development (USAID). The Capacity Project applies proven and promising approaches to improve the quality and use of priority health care services in developing countries by:

- Improving workforce planning and policy making;
- Developing better education and training systems for the workforce; and
- Strengthening systems to support workforce performance.

Led by IntraHealth International, the Capacity Project partnership includes: Emerging Markets Group, Ltd. (EMG); Interchurch Medical Assistance, Inc. (IMA); JHPIEGO; Liverpool Associates in Tropical Health (LATH); Management Sciences for Health (MSH); Program for Appropriate Technology in Health (PATH); and Training Resources Group, Inc. (TRG). <http://www.capacityproject.org>

---

Editors: Julia Bluestone  
Rebecca Chase  
Enriquito R. Lu

Editorial Assistance: Dana Lewison  
Melissa McCormick

Cover Design: Youngae Kim

Graphic Assistance and Layout: Youngae Kim  
Deborah Raynor  
Jamie Wolfe

Illustrations: New figures 5-1 to 5-5 (in Chapter 5) and D-1 to D-7 (in Appendix D) were created by Kimberly Battista.

This reference manual is based on the following two publications:

*IUD Guidelines for Family Planning Service Programs: A Problem-Solving Reference Manual* (Third Field-Test Draft for Pakistan), by Lu R, Bluestone J, Chase R, and Lewison D (eds). Copyright © 2005 by JHPIEGO. All rights reserved.

*IUD Guidelines for Family Planning Service Programs: A Problem-Solving Reference Manual*, 2nd ed, by McIntosh N, Kinzie B, and Blouse A (eds). Copyright © 1998 by JHPIEGO. All rights reserved.

TRADEMARKS: All brand and product names are trademarks or registered trademarks of their respective companies.

ISBN 0-929817-90-7

Printed in the United States of America

# TABLE OF CONTENTS

<b>Abbreviations and Acronyms .....</b>	<b>vii</b>
<b>Preface .....</b>	<b>ix</b>
<b>Acknowledgments.....</b>	<b>xi</b>
<b>How This Learning Package Is Intended to Be Used.....</b>	<b>xii</b>
<b>CHAPTER ONE: INTRODUCTION TO INTRAUTERINE CONTRACEPTIVE DEVICES</b>	
Background .....	1-1
Basic Information about the IUD.....	1-3
Addressing Common Misconceptions about the IUD .....	1-6
Overview of the WHO Medical Eligibility Criteria.....	1-8
Overview of Quality IUD Services .....	1-14
<b>CHAPTER TWO: FAMILY PLANNING EDUCATION AND COUNSELING</b>	
Background .....	2-1
Tips for Effective Education.....	2-3
Tips for Effective Counseling.....	2-4
The Counseling Process .....	2-5
<b>CHAPTER THREE: INFECTION PREVENTION</b>	
Background .....	3-1
Overview of Infection Prevention for General Clinical Practice .....	3-2
Specific Infection Prevention Tips for IUD Insertion or Removal.....	3-10
<b>CHAPTER FOUR: CLIENT ASSESSMENT</b>	
Background .....	4-1
Assessment.....	4-2
Next Steps.....	4-15
<b>CHAPTER FIVE: IUD INSERTION AND REMOVAL</b>	
Background .....	5-1
Essential Supplies .....	5-2
IUD Insertion.....	5-4
IUD Removal .....	5-15
<b>CHAPTER SIX: FOLLOW-UP CARE AND MANAGEMENT OF POTENTIAL PROBLEMS</b>	
Background .....	6-1
Follow-Up Visits.....	6-2
Management of Potential Problems .....	6-5

**APPENDIX A: ADDITIONAL INFORMATION ON CHEMICALS USED IN INFECTION PREVENTION PROCESSES**

**APPENDIX B: IUD CHECKLISTS**

**APPENDIX C: INSTRUCTIONS FOR LOADING THE REGULAR COPPER T 380A IN ITS STERILE PACKAGE**

**APPENDIX D: INSTRUCTIONS FOR LOADING THE TCU 380A WITH SAFE LOAD IN ITS STERILE PACKAGE**

**BIBLIOGRAPHY**

**FHI'S QUICK REFERENCE CHART**

# TABLES, FIGURES, AND TEXTBOXES

## TABLES

Table 1-1.	Categories Based on the WHO MEC for Contraceptive Use .....	1-9
Table 2-1.	The GATHER Technique .....	2-7
Table 3-1.	Steps in Processing Instruments, Gloves, and Other Items Used in IUD Services.....	3-13
Table 4-1.	Targeted History and Follow-Up for Potential IUD Users .....	4-4
Table 4-2.	Targeted Physical Examination and Follow-Up for Potential IUD Users.....	4-13
Table 5-1.	Key Messages for Women Who Have Just Had an IUD Inserted .....	5-13
Table A-1.	Preparing Dilute Chlorine Solution from Liquid Bleach (Sodium Hypochlorite Solution) for Decontamination and HLD.....	A-2
Table A-2.	Preparing Dilute Chlorine Solution from Dry Powder .....	A-3
Table A-3.	Advantages and Disadvantages of Commonly Used Chemicals Approved for Use in HLD .....	A-4
Table A-4.	Preparing and Using Chemical Disinfectants .....	A-5

## FIGURES

Figure 1-1.	Copper T 380A IUD .....	1-3
Figure 1-2.	Copper T 380A IUD Inside the Uterus.....	1-3
Figure 1-3.	Flowchart Showing General Steps Involved in IUD Insertion.....	1-15
Figure 3-1.	Processing Surgical Instruments, Gloves, and Other Items.....	3-5
Figure 5-1.	Instruments and Other Key Items Needed for IUD Insertion.....	5-3
Figure 5-2.	“Anatomy” of the Copper T 380A and the TCu 380A with Safe Load .....	5-4
Figure 5-5.	Inserting the Loaded IUD .....	5-10
Figure C-1.	Vertical Stem of T Fully inside Insertion Tube.....	C-1
Figure C-2a.	Placing White Plunger Rod inside Insertion Tube .....	C-2
Figure C-2b.	Plunger Rod almost Touching Bottom of T .....	C-2
Figure C-3.	Positioning IUD and Bending Arms of T.....	C-2
Figure C-4.	Inserting Folded IUD Arms into Insertion Tube .....	C-3
Figure C-5.	Using Blue Depth-Gauge to Set Depth of Uterus on Insertion Tube .....	C-4
Figure C-6.	IUD Fully Loaded in Insertion Tube.....	C-4
Figure D-1.	Vertical Stem of T Fully inside Insertion Tube.....	D-1
Figure D-2a.	Placing White Plunger Rod inside Insertion Tube .....	D-2
Figure D-2b.	Plunger Rod almost Touching Bottom of T .....	D-2
Figure D-3a.	Stabilizing Safe Load Device.....	D-3
Figure D-3b.	Pushing Arms of T into Safe Load Device.....	D-3
Figure D-4.	Pulling Insertion Tube out of Safe Load Device .....	D-3
Figure D-5.	Introducing Arms of T into Insertion Tube .....	D-3
Figure D-6.	Removing IUD from Safe Load Device .....	D-4
Figure D-7.	Using Blue Depth-Gauge to Set Depth of Uterus on Insertion Tube .....	D-4

## TEXTBOXES

Textbox 1-1.	Immediate Postpartum IUD Insertion: An Opportunity Too Good to Pass Up? .....	1-12
Textbox 1-2.	Screening for STIs Where Laboratory Testing Is Not Available .....	1-13
Textbox 2-1.	Client Rights .....	2-2
Textbox 2-2.	Enhancing Client Understanding/Retention of Information.....	2-4
Textbox 2-3.	Tips for Group Education .....	2-4
Textbox 2-4.	Client Messages about Basic Attributes of the IUD .....	2-10
Textbox 2-5.	Responding to Rumors and Myths about the IUD .....	2-11
Textbox 3-1.	General Guidelines for Processing Instruments, Gloves, and Other Items.....	3-6
Textbox 3-2.	How to High-Level Disinfect Surgical Gloves by Steaming .....	3-9
Textbox 4-1.	Self-Assessment Tool for “Very High Individual Risk” of Gonorrhea or Chlamydia .....	4-10
Textbox 4-2.	Support and Care for Women Who Might Have Gonorrhea or Chlamydia .....	4-15
Textbox 4-3.	What to Do if the Woman Is Not Currently Eligible for IUD Use .....	4-16
Textbox 5-1.	PAINS: Warning Signs for IUD Users.....	5-15
Textbox 5-3.	Guidelines for Switching to Another Contraceptive Method and Need for Back-Up Methods.....	5-18
Textbox 6-1.	Follow-Up for Women Who Are Dissatisfied with the IUD.....	6-3
Textbox 6-2.	Follow-Up for Women Experiencing Menstrual Changes.....	6-3
Textbox A-1.	Formula for Making Dilute Chlorine Solution from Concentrated Solution.....	A-2
Textbox A-2.	Formula for Making Dilute Chlorine Solution from Dry Powder .....	A-3



# ABBREVIATIONS AND ACRONYMS

AIDS	acquired immunodeficiency syndrome
ARHP	Association of Reproductive Health Professionals
ARV	antiretroviral therapy
CDC	Centers for Disease Control and Prevention
cm	centimeter
COC	combined oral contraceptive
Cu	copper
DHS	demographic health survey
FHI	Family Health International
g	gram
GATHER	greet, ask, tell, help, explain, return visit/refer
Hb	hemoglobin
HBV	Hepatitis B virus
Hct	hematocrit
HIV	human immunodeficiency virus
HLD	high-level disinfection <i>or</i> high-level disinfected
IM	intramuscular
IUD	intrauterine contraceptive device
LMP	last menstrual period
LNG-IUS	levonorgestrel intrauterine system
MEC	medical eligibility criteria
mg	milligram
mm	millimeter
NSAID	non-steroidal anti-inflammatory drug
PAINS	period-related problems or pregnancy symptoms; abdominal pain or pain during intercourse; infections or unusual vaginal discharge; not feeling well, fever, chills; string problems
PID	pelvic inflammatory disease
STI	sexually transmitted infection
TCu 380A	Copper T 380A IUD
USAID	United States Agency for International Development
USFDA	United States Food and Drug Administration
WHO	World Health Organization



# PREFACE

Results of recent studies and literature reviews have confirmed that the intrauterine contraceptive device (IUD) is a safe and highly effective, long-term, reversible contraceptive method, and that health risks associated with the method are negligible. This growing body of evidence challenges some long-standing misconceptions about the IUD, and has led to many important changes in global practices and recommendations. Based on the World Health Organization's latest medical eligibility criteria for use of copper-bearing IUDs, **most women can generally use the IUD**, including (but not limited to):

- Women who have never been pregnant before
- Women with a history of ectopic pregnancy
- Women who are HIV-infected and are clinically well
- Women who have AIDS and are on antiretroviral therapy and clinically well
- Women with a history of pelvic inflammatory disease (assuming no known current risk factors for gonorrhea or chlamydia)
- Women who have a sexually transmitted infection (STI) other than gonorrhea or chlamydia (assuming no known current risk factors for these STIs)
- Women who live in areas with a high prevalence of STIs (assuming no known current risk factors for gonorrhea or chlamydia)

Thus, there is a worldwide resurgence of interest in this method, as well as an increased demand for well-trained staff who exhibit up-to-date knowledge, attitudes, and skills in providing IUD services. In response to this need, JHPIEGO has updated and revised its *IUD Guidelines for Family Planning Service Programs* learning package, which includes this reference manual and all of the materials needed to conduct a competency-based, inservice training course for service providers (see also *How This Learning Package Is Intended to Be Used*).

Specific objectives of this learning package are to provide up-to-date, essential information about—and help develop and strengthen skills in—the following areas:

- Basic information about the Copper T 380A (e.g., mechanism of action, effectiveness, effective life, side effects, health benefits and potential health risks), as well as common misconceptions

- The World Health Organization’s latest recommendations for use of copper-bearing IUDs, and how they are applied in clinical practice
- Education and counseling of potential IUD clients and IUD users
- Simple, cost-effective infection prevention practices that should be used in providing IUD services to minimize the risk of infection and disease transmission for clients and health care staff
- Assessment (including a targeted history and physical examination) of potential IUD users to determine whether they are eligible for IUD use
- Step-by-step procedures for the safe and gentle insertion and removal of the Copper T 380A (regular or with Safe Load)
- Routine follow-up care of IUD users, as well as management of side effects and other potential problems associated with IUD use

**Note:** There are several different types of IUDs available on the market. Two commonly available IUDs are the Copper T 380A (regular and with Safe Load) and the Multiload Cu375, both copper-bearing IUDs. This learning package focuses on the knowledge and skills needed to provide services for the Copper T 380A; however, supplemental materials for Multiload Cu375 are also provided in the Trainer’s Notebook.

# ACKNOWLEDGMENTS

This is the third edition of *IUD Guidelines for Family Planning Programs: A Problem-Solving Reference Manual*. It and the accompanying learning resource package were revised to reflect recent changes in the World Health Organization's *Medical Eligibility Criteria for Contraceptive Use*, Third Edition (WHO 2004). This revision was completed for the Capacity Project through support provided by the United States Agency for International Development, under the terms of Award No. GPO-A-00-04-00026-00; and would not have been possible without initial support provided by Constella Futures (formerly Futures Group)/Key Social Marketing Pakistan Program, also through support provided by the U.S. Agency for International Development, under the terms of Award No. 391-A-00-0301017-00. The views expressed in this publication are those of JHPIEGO and do not necessarily reflect the views of the U.S. Agency for International Development or the United States Government.

Publications that were most helpful in this revision were: *Family Planning: A Global Handbook for Providers* (WHO and Johns Hopkins Bloomberg School of Public Health/Center for Communication Programs 2006), and *Contraceptive Technology*, 18th Edition (Hatcher et al. 2004). These and other key publications are specifically cited throughout the manual, and fully referenced in the bibliography.

JHPIEGO would like to thank the following individuals for their review and other valuable contributions to the development of this document:

- Roy Jacobstein, EngenderHealth/ACQUIRE
- Peter Johnson, JHPIEGO
- Tom Milroy, IntraHealth/CAPACITY
- Roberto Rivera, Family Health International
- Lois Schaefer, U.S. Agency for International Development
- Cathy Solter, Pathfinder
- Ushma Upadhyay, Center for Communication Programs/INFO Project

The Maximizing Access and Quality Initiative IUD (MAQ/IUD) working group also provided some valuable tools and input.

# HOW THIS LEARNING PACKAGE IS INTENDED TO BE USED

---

Providers play a pivotal role in the IUD's availability and use. Providers not only conduct IUD counseling, insertion, and removal, they serve as “gatekeepers” whose attitudes and actions influence whether and how clients use IUDs.

~ From Essential Knowledge about the IUD, in the IUD Toolkit

---

With the resurgence of interest in the IUD comes an increased need for providers who have knowledge, skill, and overall competency in providing quality IUD services. To help address this need, JHPIEGO has updated and revised its *IUD Guidelines for Family Planning Service Programs* learning package, which includes a problem-solving reference manual, notebook for trainers, handbook for participants, and presentation graphics—all of the materials needed to conduct a competency-based, inservice training course for service providers.

The reference manual is a concise, up-to-date, evidence-based resource intended for use by family planning service providers, clinical managers or supervisors, and clinical trainers. Chapter 1 contains up-to-date, essential information about the Copper T 380A, as well as the World Health Organization’s latest recommendations about the use of copper-bearing IUDs. The rest of the manual is arranged sequentially according to the usual way in which clients are cared for—starting with family planning education and counseling for potential IUD users (Chapter 2) and infection prevention practices used in IUD services (Chapter 3), which provide a foundation for and are integrated with all other aspects of care; continuing with assessment of potential IUD users (Chapter 4) and insertion or removal of the IUD (Chapter 5); and ending with routine follow-up of IUD users, as well as management of potential problems associated with IUD use (Chapter 6).

Although the manual can be used in the context of IUD service delivery, it is designed to work primarily as a reference document during clinical training. The course outline, exercises, and other course materials are specifically keyed to work with the manual, which becomes a “common ground” for trainers and participant-providers as they navigate together through the course.

JHPIEGO’s *IUD Guidelines for Family Planning Service Programs* learning package is part of the **IUD Toolkit**—a comprehensive, online resource that offers the best available knowledge and practices on how to develop and expand IUD services in reproductive health programs (compiled by members of the IUD Subcommittee of USAID’s Maximizing Access and Quality Initiative). <http://www.maqweb.org/iudtoolkit/index.shtml>

## ONE

# INTRODUCTION TO INTRAUTERINE CONTRACEPTIVE DEVICES

### BACKGROUND

For more than 30 years, women throughout the world have been using the intrauterine contraceptive device (IUD) as their method of contraception. It is, in fact, the most commonly used reversible method among married women of reproductive age worldwide. According to recent estimates, almost one in five (or 153 million) married contraceptive users is currently using the IUD (Salem 2006).

The popularity of the IUD may be due in part to the high level of satisfaction among IUD users. Women who use the IUD are more satisfied with their choice of contraception than are those using other reversible methods (99% versus 91% for pill users), according to research conducted in the United States (Forrest 1996). Data compiled from a US-based study and an international World Health Organization (WHO) study suggested that about 92% of women are still using the Copper T 380A at 1 year after insertion (Association of Reproductive Health Professionals [ARHP] 2004). Formative research shows that some attributes that IUD users like most about the method are that it:

- Offers highly effective, long-term protection against pregnancy, with immediate return to fertility upon removal;
- Has no hormonal side effects;
- Is inexpensive over time (no costs after initial cost); and
- Is convenient—does not require daily action on the part of the user, or repeated clinic visits for supplies (Rivera et al. 2006).

Despite the overall popularity of the IUD, the bulk of IUD use is concentrated in relatively few countries. Most notable among these is China, where almost 92 million (or 60%) of the world's married IUD users reside. In many countries in Eastern Europe, Central Asia, the Near East, and North Africa, at least half of the women who use contraception use the IUD. In other parts of the world, however, the IUD is among the least used methods. In India, for example, 3% of married women of reproductive age are IUD users; in North America, that percentage is even lower at 2% (Salem 2006).

### Old Myths, New Research

One of the main reasons that the IUD is under-used in some parts of the world may be that clinicians and potential IUD clients lack

---

Worldwide, almost one in five married women who use contraception uses the IUD.

---

accurate, up-to-date information about the IUD. As a result, they base their decisions about whether to provide or use the IUD on myths and misconceptions about the method, rather than on the latest scientific evidence. A review of obstetric textbooks published in the United Kingdom and United States concluded that the disadvantages of the IUD tend to be exaggerated, while the advantages are often understated (Espey and Ogbourn 2002). In another study, similar misinformation was found in about half of consumer-oriented websites (Weiss and Moore 2003). The labeling on some IUD packages also helps perpetuate under-use of the IUD by suggesting overly restrictive criteria for who can use the method (ARHP 2004).

---

Recent studies confirm that the IUD is a safe and extremely effective contraceptive method that is appropriate for use by **most** women.

---

Results of recent studies, however, confirm that the IUD is a safe and extremely effective contraceptive method that is appropriate for use by most women—including those who are under 20 years of age, are nulliparous or nulligravid, are HIV-infected or have AIDS but are clinically well and on antiretroviral (ARV) therapy, or have a history of pelvic inflammatory disease (PID) or ectopic pregnancy. The studies also establish the negligibility of associated risks. This growing body of evidence has led to important changes in the WHO medical eligibility criteria (MEC) for contraceptive use, which suggest that the advantages of IUD use generally outweigh the risks for most women, even in the presence of many conditions previously thought to be precautions or contraindications to IUD use (such as those listed above). Thus, the IUD is re-emerging as an excellent choice for most women seeking long-term, reversible contraceptive protection.

### **Research to Practice**

Although the new research is promising, it will take time for practice to catch up, as there is a lack of providers trained and/or skilled and confident in delivering IUD services, especially in countries where demand for IUDs has been historically low. This reference manual and the accompanying courseware have been updated and revised specifically to help address this need. Together, these materials aim to provide clinicians, clinic managers, and clinical trainers with the latest, essential information on the IUD as well as the skills needed to deliver the full range of quality IUD services. The manual is arranged sequentially according to the usual way in which clients are cared for—starting with family planning education and counseling (Chapter 2) and infection prevention practices (Chapter 3), which provide a foundation for and are integrated with all other aspects of care; continuing with client assessment (Chapter 4) and insertion (or removal) of the IUD (Chapter 5); and ending with routine follow-up of IUD users, as well as management of potential problems associated with IUD use (Chapter 6).



## BASIC INFORMATION ABOUT THE IUD

### Types of IUDs

Common types of IUDs available worldwide are as follows:

- Copper-bearing, which includes the Copper T 380A (TCu 380A, TCu 380A with Safe Load; and TCu 200C), the Multiload (MLCu 250 and Cu375), and the Nova T
- Medicated with a steroid hormone, such as Mirena®, the levonorgestrel-releasing intrauterine system (LNG-IUS)

### The Copper T 380A

The main IUD featured in this learning package is the Copper T 380A (or Copper T), which is:

- widely used;
- well known for its effectiveness, ease of insertion and removal, wide margin of safety, acceptability to clients, and low cost; and
- effective for at least 12 years.

Information is also provided on the TCu 380A with “Safe Load,” which is a type of Copper T that comes with a device that makes it easier to load in its sterile package.

The Copper T 380A looks like the letter “T” and contains barium sulfate so that it can be seen via X-ray. As shown in Figure 1-1, there are small copper bands on each “arm” of the T, which ensure that copper is released high in the fundus of the uterus (Figure 1-2). The “stem” is also wound with copper wire. A thin polyethylene string is attached to the bottom of the stem for easy removal.

**Note:** All mentions of the IUD in this learning package refer to the Copper T 380A (regular or Safe Load) unless otherwise indicated. All mentions of the Copper T or Copper T 380A refer to both the regular and Safe Load varieties unless otherwise indicated.

Figure 1-1. Copper T 380A IUD<sup>1</sup>

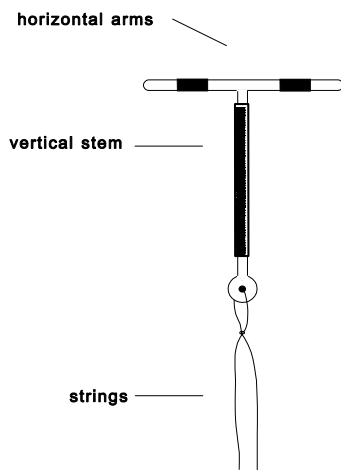
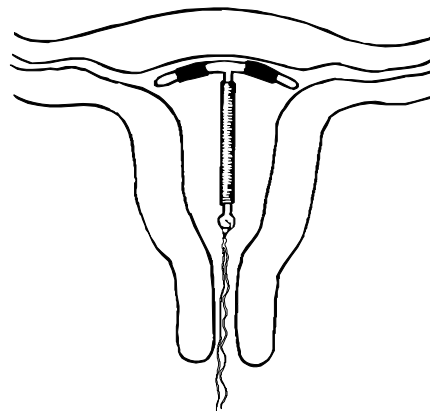


Figure 1-2. Copper T 380A IUD Inside the Uterus<sup>1</sup>



<sup>1</sup> Source: The Population Council and the Program for Appropriate Technology in Health (PATH) 1989.

## **Introduction to Intrauterine Contraceptive Devices**

For more information about the “anatomy” of the IUDs and their packaging, as well as the associated terminology, see page 5-3 and 5-4.

### **Mechanism of Action**

Copper-bearing IUDs, such as the Copper T, act primarily by preventing fertilization (Rivera et al. 1999). Copper ions decrease sperm motility and function by altering the uterine and tubal fluid environment, thus preventing sperm from reaching the fallopian tube and fertilizing the egg.

### **Effectiveness**

The IUD is a highly effective form of long-term, reversible contraception, with an associated failure (pregnancy) rate of less than 1% (0.8%) in the first year of use (Trussell 2004a). In a long-term, international study sponsored by the WHO, the average annual failure rate was 0.4% or less, and the average cumulative failure rate over the course of 12 years was 2.2%, which is comparable to that of tubal sterilization (United Nations Development Programme et al. 1997). Service providers can tell their family planning clients that the IUD is the most effective, reversible contraceptive currently available.

### **Effective Life**

The latest scientific evidence shows that the Copper T 380A is effective for at least 12 years (United Nations Development Programme et al. 1997), although the US Food and Drug Administration (USFDA) has approved it for only 10 years (as of this printing). Clients who have had a Copper T inserted should be advised that it should be replaced or removed 12 years from the date of insertion.

#### **A Word about Shelf Life**

According to the USFDA, the **shelf life** of each presterilized Copper T 380A insertion package is 7 years. It is important to note that the expiration date on the IUD package refers only to the shelf life of the sterility of the package, and not to the contraceptive effectiveness of the IUD itself. This means that even if an IUD is inserted on the day before the expiration date (provided the package is not torn or damaged), it is still effective for the full lifespan of contraceptive efficacy—in other words, the Copper T 380A would be effective for a full 12 years from that date. On the expiration date, the IUD should be discarded.

### **Return to Fertility**

A woman’s fertility returns immediately after an IUD is removed (Andersson et al. 1992; Belhadj et al. 1986). This message should be made very clear to clients having an IUD removed: unless they want to get pregnant, they should have another IUD inserted immediately after removal (if desired and appropriate) or start another contraceptive method.

## **Side Effects**

A common side effect of copper-bearing IUDs is menstrual changes. Use of the Copper T has been associated with an increase of up to about 50% in the duration/amount of menstrual bleeding, and this is the most common reason for removal (Penney et al. 2004). Changes in bleeding patterns, such as spotting/light bleeding (between periods), may also occur in the first few weeks. Finally, some women may experience discomfort or cramping during IUD insertion (Grimes 2004) and for the next several days.

Cramping/pain and changes in bleeding amount/patterns usually are not harmful for the woman and often subside within the first few months after IUD insertion. Women should be advised of this common side effect before IUD insertion, and assessed for and counseled about it if needed afterward. Non-steroidal anti-inflammatory drugs (NSAID) can lessen symptoms (WHO 2004b), and good counseling can encourage continued use of the method (Backman et al. 2002; Zetina-Lozano 1983).

## **Health Benefits and Potential Health Risks**

Nonhormonal IUDs, such as the Copper T, may protect against endometrial and cervical cancer (Hubacher and Grimes 2002).

Potential health risks associated with the IUD, which are uncommon or rare, are discussed below.

- Uterine perforation—Perforation of the uterus during IUD insertion has been shown to be rare, with fewer than 1.5 perforations per 1000 insertions occurring in large clinical trials (United Nations Development Programme et al. 1997; Trieman et al. 1995). This minimal risk is associated with level of provider skill and experience (Harrison-Woolrych et al. 2003). When the IUD is inserted by a skilled provider, the risk has been shown to be as low as 1 per 1000 insertions (WHO 1987) and 1 per 770–1600 insertions (Nelson 2000). If perforation occurs, the risk of serious complications is low and the need for surgical intervention rare (Penney et al. 2004).
- Expulsion—Although IUD failure is rare, expulsion is the most common cause (ARHP 2004). In the first year of IUD use, 2–8% of women spontaneously expel their IUDs (Trieman et al. 1995). Several factors influence the risk of expulsion—the most important of which is the skill and experience of the provider (Chi 1993). Another important factor is timing. Expulsion is most likely to occur within the first 3 months postinsertion and is more common in women who are nulliparous, have severe dysmenorrhea, or have heavy menstrual flow (Zhang et al. 1992). The risk of expulsion is higher (11–25% after 12 months of use) when the IUD is inserted immediately after childbirth (more than 10 minutes but less than

## Introduction to Intrauterine Contraceptive Devices

48 hours after delivery of the placenta) (Trieman et al. 1995), and higher when inserted immediately after a second-trimester abortion (Grimes, Schulz, and Stanwood 2002). Correct insertion, with the IUD placed high in the uterine fundus, is thought to reduce the chances of expulsion.

- Infection—According to the latest research, the risk of upper genital tract infection among IUD users is less than 1%, which is much lower than previously thought. This minimal risk is highest within the first 20 days after IUD insertion, and is thought to be related to insertion technique (due to lack of proper infection prevention practices) rather than to the IUD itself (Hatcher et al. 2004). After the first 20 days, the risk of infection among IUD users appears to be comparable to that among non-IUD users (Hatcher et al. 2004).

### ADDRESSING COMMON MISCONCEPTIONS ABOUT THE IUD

As previously mentioned, many misconceptions about the IUD remain despite scientific evidence to the contrary. The following section presents recent research to refute some of these misconceptions, while providing a basis for new recommendations and practices related to intrauterine contraception.

<b>The IUD <i>does not</i> act as an abortifacient.</b>	Studies suggest that the IUD prevents pregnancy primarily by preventing fertilization rather than inhibiting implantation of the fertilized egg (Rivera et al. 1999; Alvarez et al. 1988; Segal et al. 1985). This is particularly true of the copper-bearing IUDs.
<b>The IUD <i>does not</i> increase a woman's risk of ectopic pregnancy.</b>	The IUD reduces the risk of ectopic pregnancy by preventing pregnancy. Because IUDs are so effective at preventing pregnancy, they also offer excellent protection against ectopic pregnancy. Women who use copper-bearing IUDs are 91% less likely than women using no contraception to have an ectopic pregnancy (Sivin 1991).
<hr/> <p>The absolute number of ectopic pregnancies among IUD users is much lower than that among the general population.</p> <hr/>	<p>The following points should also be considered:</p> <ul style="list-style-type: none"><li>● In the unlikely event that an IUD user does become pregnant, that pregnancy is more likely to be ectopic than is a pregnancy in a nonuser because the IUD offers less protection against ectopic than intrauterine pregnancy (Nelson 2000). Ectopic pregnancy is a serious condition that requires emergency care.</li><li>● A pregnancy occurring in an IUD user is much more likely to be normal than ectopic (6–8%). (This 6–8% is out of the very small number of women who get pregnant with an IUD in place.)</li></ul>

**The IUD *does not* increase a woman’s risk of ectopic pregnancy. (continued)**

- Among IUDs, the Copper T 380A and Multiload Cu375 are lowest in rates of ectopic pregnancy (WHO 1987). A long-term study of women using the Copper T 380A found the rate to be less than 1 (0.09%) per 100 women at 1 year, and less than 1 (0.89%) per 100 women at 10 years (Ganacharya, Bhattoa, and Batar 2003).
- Women with a history of ectopic pregnancy can use the IUD with no restrictions.

**The IUD *does not* cause PID, nor does the IUD need to be removed to treat PID.**

Strict randomized controlled trials and literature reviews reveal that PID among IUD users is rare (ARHP 2004; Grimes 2000). Early studies that reported a link between PID and IUD use were flawed and poorly designed. Inappropriate groups were used for comparison, infection in IUD users was over-diagnosed, and there was a lack of control for confounding factors (Buchan et al. 1990; Vessey et al. 1981).

Here are some important points about PID and the IUD based on more recent research:

- During the first 3–4 weeks after IUD insertion, there is a slight increase in the risk of PID among IUD users compared to non-IUD users, **but it is still rare** (less than 7/1000 cases). After that, an IUD user appears to be no more likely to develop PID than a non-IUD user (Farley et al. 1992).
- PID in IUD users is caused by the STIs gonorrhea and chlamydia, not the IUD itself (Darney 2001; Grimes 2000). However, the risk is still very low, with an estimated 3 cases per 1000 insertions in settings with a high prevalence (10%) of these STIs (Shelton 2001).
- If PID occurs, the infection can be treated while the IUD is kept in place, if the woman so desires. Studies have shown that removing the IUD does not have an impact on the clinical course of the infection. If the infection responds to treatment within 72 hours, the IUD does not need to be removed (WHO 2004b).
- Randomized controlled trials and cohort studies reveal that the monofilament string does not increase the risk of PID (Grimes 2000).
- Women who have a history of PID can generally use the IUD (the advantages generally outweigh the risks), provided their current risk for STIs is low.

## Introduction to Intrauterine Contraceptive Devices

<b>The IUD <i>does not</i> cause infertility.</b>	Infertility caused by tubal damage is associated not with IUD use, but with chlamydia (current infection or—as indicated by the presence of antibodies—past infection) (Hubacher et al. 2001). Moreover, there is an immediate return to fertility after an IUD has been removed (Belhadj et al. 1986). In one study, 100% of women who desired pregnancy (97 of 97) conceived within 39 months of IUD removal (Skjeldestad and Bratt 1988).
<b>The IUD <i>is suitable</i> for use in nulliparous women.</b>	Nulliparous women can generally use the IUD (the advantages generally outweigh the risks). In theory, the smaller size of a nulligravid uterus may increase the risk of expulsion, whereas uterine enlargement, even if due to an abortion, may promote successful IUD use (Hatcher et al. 2004). Expulsion rates tend to be slightly higher in nulliparous women compared to parous women (Grimes 2004).
<b>The IUD <i>can be</i> safely used by HIV-infected women who are clinically well.</b>	HIV-infected women who are clinically well can generally use the IUD (the advantages generally outweigh the risks). A large study in Nairobi showed that HIV-infected women had no significant increase in the risk of complications, including infection in early months, than HIV-negative women (Sinei et al. 2001). In another study of HIV-infected and HIV-negative IUD users with a low risk of STI, no differences were found in overall or infection-related complications between the two groups (Sinei et al. 1998).
<b>The IUD <i>does not</i> increase the risk of HIV transmission.</b>	There is no current evidence that use of the IUD in HIV-infected women leads to increased risk of HIV transmission. Studies have shown that among HIV-infected women using the IUD, there is no increase in viral shedding and no statistically significant increase in HIV transmission to male partners (ARHP 2004; Richardson et al. 1999).
<b>The IUD <i>does not</i> interfere with ARV therapy.</b>	Women who have AIDS, are on ARV therapy, and are clinically well can generally use the IUD (advantages generally outweigh the risks). Because it is a non-hormonal family planning method, the IUD is not affected by liver enzymes and will not interfere with or be affected by ARV therapy (ARHP 2004; Hatcher et al. 2004).

---

**Remember:**  
Most women can generally use the IUD.

---

## OVERVIEW OF THE WHO MEDICAL ELIGIBILITY CRITERIA

The WHO MEC for contraceptive use (first issued: 1996; revised: 2000, 2003, 2004) help providers assist clients in weighing the risks and advantages of different family planning methods relative to specific “conditions.” A condition is either a biologic characteristic

(e.g., age, reproductive history) or a known medical condition (e.g., HIV, diabetes, anemia) that may have an impact on the effectiveness or safety of a given contraceptive. In the WHO system, a woman’s eligibility for using a specific method falls into one of four categories, depending on the presence/absence of various condition(s). These categories are summarized in Table 1-1.

**Table 1-1. Categories Based on the WHO MEC for Contraceptive Use<sup>2</sup>**

CATEGORY	DESCRIPTION	WITH CLINICAL JUDGMENT <sup>a</sup>	WITH LIMITED CLINICAL JUDGMENT <sup>b</sup>
1	A condition for which there is no restriction for the use of the contraceptive method.	Use method in any circumstances.	Yes (Use the method.)
2	A condition for which the advantages of using the method generally outweigh the theoretical or proven risks.	Generally use the method.	
3	A condition for which the theoretical or proven risks usually outweigh the advantages of using the method.	Use of method not usually recommended unless other more appropriate methods are not available or acceptable.	No (Do not use the method.)
4	A condition that represents an unacceptable health risk if the contraceptive method is used.	Method not to be used.	

<sup>a</sup> In care situations where resources for clinical judgment are in place (e.g., availability of skilled care, access to a wide range of services), the four-category framework corresponds to four possible determinations of whether a woman can use an IUD.

<sup>b</sup> In care situations where resources for clinical judgment are limited (e.g., community-based services), the four-category framework is simplified into two possible determinations of whether a woman can use an IUD.

Sometimes a given condition is considered one category for *initiating* use (i.e., insertion) and another for *continuing* use. For example, a woman with PID should not have an IUD inserted (Category 4), but can continue to use an IUD already in place while receiving appropriate treatment (Category 2), if she so desires.

---

Any risk posed by a method should be weighed against the risk posed by unintended pregnancy on a case-by-case basis.

---

<sup>2</sup> Adapted from: WHO 2004a. (Footnotes a and b added per the present publication.)

## Introduction to Intrauterine Contraceptive Devices

**Note:** WHO's four-category system is intended to be used in the context of clinical judgment. This means that the provider has the knowledge, skills, and resources necessary to determine whether the benefits of using an IUD outweigh the risks for a particular woman. This capacity is especially important when there may be some question about whether the IUD is an appropriate choice for a particular woman. For example, a provider may—after considering all the factors involved—determine that one woman who is anemic is a good candidate for IUD use, but advise another woman with anemia (e.g., if it is severe) to consider other, more appropriate methods. In making this determination, the provider may consider and weigh factors such as:

- Risks posed by the method versus those posed by an unintended pregnancy
- Severity of the woman's condition, and whether she is undergoing adequate treatment
- Presence of other conditions
- The woman's understanding of any special risks involved
- Access to additional services and follow-up care, as needed
- Availability/acceptability of other contraceptive methods
- Any other circumstances or factors that may be relevant

In situations in which the provider does not have the knowledge, skills, or resources necessary to make such determinations, the four categories can be simplified into two, as shown in the far right column of Table 1-1. In the context of this simplified system, women with Category 1 and 2 conditions can use the IUD, and women with Category 3 and 4 conditions can not. Or, the provider may refer a woman to a higher level facility if there is some question about whether she can use the IUD.

Following are considerations for using the IUD based on the WHO MEC (all are adapted from WHO 2004a). **These considerations apply to all copper-bearing IUDs, and refer to both insertion and continuation of the IUD unless otherwise indicated.** See the end of the manual for a quick-reference chart summarizing the WHO MEC for use of copper-bearing IUDs.

**CATEGORY 1:** Women with Category 1 conditions **can use the IUD with no restrictions.** Women with conditions that fall into this category include, but are not limited to, the following:

### Reproductive

- Women with a history of ectopic pregnancy.
- Women who are immediately following a first-trimester abortion (spontaneous or induced), provided there is no evidence of infection.
- Women who are 4 weeks or more postpartum, provided there is no evidence of infection.
- Women who have benign ovarian tumors (or cysts) or uterine fibroids that do not distort the uterine cavity.



**STIs/  
Genital Tract Infections**

- Women with a genital tract infection that is not sexually transmitted, such as vaginitis (e.g., bacterial vaginosis, candida albicans).
- Women who have a history of PID with a subsequent pregnancy (assuming there are no known current risk factors for STIs).
- Women who have breast disease, including breast cancer.
- Women who have viral hepatitis or malaria.
- Women who have diabetes, hypertension, or “uncomplicated” valvular heart disease.
- Women who smoke or are obese.

**CATEGORY 2:** The following women **can generally use the IUD** (the advantages generally outweigh the risks), although additional care/follow-up may be needed:

**Reproductive**

- Women who are less than 20 years of age (and nulliparous) or are nulliparous, as there is a slightly greater risk of expulsion due to the smaller size of the uterus.
- Women with heavy/prolonged or painful menstruation, endometriosis, or severe dysmenorrhea, although they may wish to consider another family planning method, as heavier menstrual bleeding and cramping are common side effects of the IUD.
- Women who are immediately following a second-trimester abortion (spontaneous or induced), provided there is no evidence of infection. **However, the IUD should be inserted only by a specially trained provider** (because of the increased risk of expulsion).
- Women who are less than 48 hours postpartum, provided there is no evidence of infection. **However, the IUD should be inserted only by a specially trained provider** (because of the increased risk of expulsion). For more information about immediate postpartum IUD insertion, see Textbox 1-1.
- Women who have anatomical abnormalities of the reproductive tract that do not distort the uterine cavity in a way that might interfere with IUD insertion or placement (e.g., cervical stenosis).

**Introduction to Intrauterine Contraceptive Devices**

<p><b>STIs</b></p> <hr/> <p><b>Important:</b> The IUD does not provide protection against HIV and other STIs; those at risk should be encouraged to use condoms.</p>	<ul style="list-style-type: none"> <li>• Women who have STIs other than gonorrhea or chlamydia (e.g., herpes, syphilis).</li> <li>• Women who are at risk for STIs other than gonorrhea or chlamydia (e.g., HIV, herpes, syphilis, hepatitis).</li> <li>• Women who have a history of PID without a subsequent pregnancy (assuming there are no known current risk factors for STIs).</li> </ul>
<p><b>HIV/AIDS</b></p>	<ul style="list-style-type: none"> <li>• Women who are HIV-infected <u>and</u> are clinically well.</li> <li>• Women who have AIDS, are on ARV therapy, <u>and</u> are clinically well.</li> </ul>
<p><b>General</b></p>	<ul style="list-style-type: none"> <li>• Women who have complicated valvular heart disease (e.g., artificial shunts, rheumatic heart disease), although prophylactic antibiotics are advised for IUD insertion to prevent endocarditis.</li> <li>• Women with anemia (including thalassemia, sickle cell disease, and iron-deficiency anemia), although there is some concern about increased menstrual blood loss with copper-bearing IUDs.</li> </ul>

**Textbox 1-1. Immediate Postpartum IUD Insertion: An Opportunity Too Good to Pass Up?**

Immediate postpartum insertion of IUDs is safe, effective, and convenient for women (Sevki et al. 2005). And for many women who rarely access health care services, the insertion of an IUD immediately postpartum represents a good opportunity to help them control their fertility options. Other advantages of immediate postpartum insertion include high motivation on the part of the client, as well as the assurance that she is not pregnant. The popularity of immediate postpartum IUD insertion in countries as diverse as China, Mexico, and Egypt supports the feasibility and acceptability of this approach (Grimes et al. 2003).

IUDs can be inserted any time in the first 48 hours after birth (as well as at 4 weeks or more after childbirth), provided there is no evidence of infection (Muller et al. 2005). IUDs inserted within 10 minutes of delivery of the placenta have a much lower risk of expulsion than those inserted later in the postpartum period, although the expulsion rate is still higher than for interval insertions (about 42 days after childbirth) (Grimes et al. 2003).

Additional considerations for immediate postpartum IUD insertion include the following:

- A woman should be counseled and make a decision about immediate postpartum IUD insertion during the antenatal period, so that insertion may occur within 10 minutes of delivery. This discussion/decision should not be imposed immediately postpartum.
- Because correct provider insertion technique has a large influence on retention rates after immediate postpartum insertion, providers who perform this procedure must receive special training (Bonilla et al. 2005).
- Early follow-up may be important in identifying spontaneous IUD expulsions following immediate postpartum insertions.

**CATEGORY 3:** For the following women, use **of the IUD is not recommended** (the risks generally outweigh the advantages); they should use a different method unless no other is available or acceptable:

<b>Reproductive</b>	<ul style="list-style-type: none"> <li>• Women who are 48 hours to less than 4 weeks postpartum.</li> <li>• Women with benign trophoblastic disease.</li> <li>• Women who have ovarian cancer should not have an IUD <i>inserted</i> (although they are Category 2 for <i>continuation</i>).</li> </ul>
<b>STIs</b>	<ul style="list-style-type: none"> <li>• Women who have a high individual risk for gonorrhea or chlamydia should not have an IUD <i>inserted</i> (although they are Category 2 for <i>continuation</i>). See Textbox 1-2.</li> </ul>
<b>HIV/AIDS</b>	<ul style="list-style-type: none"> <li>• Women who have AIDS but are not on ARV therapy should not have an IUD <i>inserted</i> (although they are Category 2 for <i>continuation</i>).</li> </ul>

**Textbox 1-2. Screening for STIs Where Laboratory Testing Is Not Available<sup>3</sup>**

Laboratory tests for STIs could contribute to safer use of IUDs (WHO 2004b), WHO notes, but such tests usually are not feasible for lack of facilities, equipment, and trained personnel (WHO 2003). Programs and providers need to balance the risks of not performing the tests against the benefits of making the IUD available (WHO 2004b). **Refusing women the choice of IUDs in the absence of laboratory tests for STIs would deny the great majority a method they could use safely and would create an unnecessary medical barrier.**

Since STI tests usually are not available, WHO guidance considers STI risk assessment and physical examination essential to safe use of IUDs (WHO 2004). Risk assessment conventionally has been based on the client's answers to a provider's questions about her and her partner's sexual behavior. Having the client assess her own risk of STIs is another approach.<sup>a</sup>

While risk assessment seems focused on whether a woman might get an STI in the future, its real purpose as far as IUD insertion is concerned is to gauge whether she might have a gonorrheal or chlamydial infection now, which would rule out IUD insertion.<sup>b</sup>

<sup>a</sup> Both methods are covered in Chapter 4.

<sup>b</sup> In such cases, the IUD should not be inserted until current infection with gonorrhea or chlamydia is ruled out or successfully treated.

<sup>3</sup> Source: Salem 2006. (Footnotes *a* and *b* added per the present publication.)

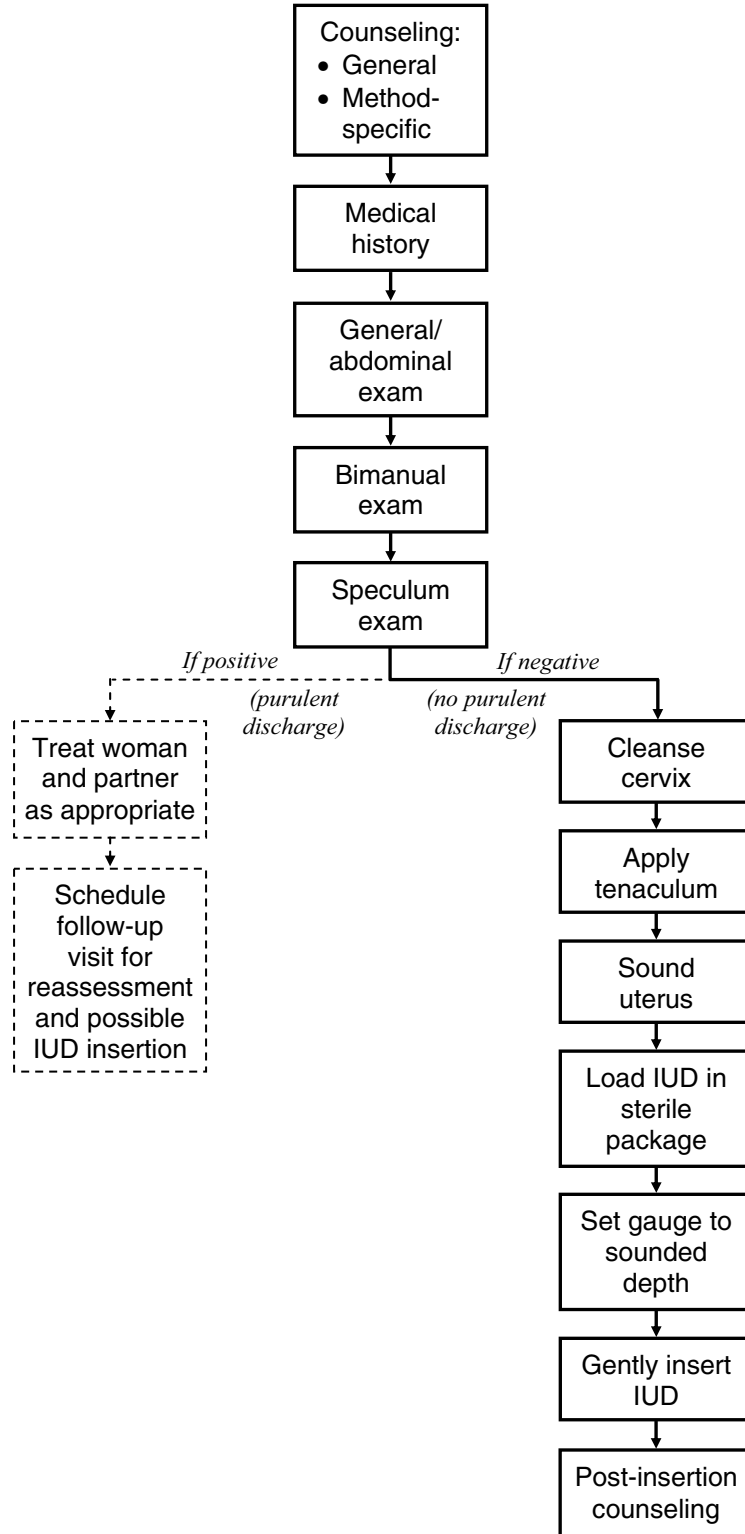
**CATEGORY 4: The following women should not use the IUD:**

<p><b>Reproductive</b></p>	<ul style="list-style-type: none"> <li>• Women who are pregnant.</li> <li>• Women who have infection or signs/symptoms of infection within 6 weeks postpartum (puerperal sepsis), or immediately following an abortion (immediate post-septic abortion).</li> <li>• Women with malignant trophoblastic disease.</li> <li>• Women with cervical or endometrial/uterine cancer should not have an IUD <i>inserted</i> (although they are Category 2 for <i>continuation</i> while awaiting evaluation).</li> <li>• Women who have anatomical abnormalities of the reproductive tract or uterine fibroids that distort the uterine cavity in a way that might interfere with IUD insertion or placement.</li> <li>• Women who have pelvic tuberculosis.</li> <li>• Women with unexplained vaginal bleeding should not have an IUD <i>inserted</i> (although they are Category 2 for <i>continuation</i> while awaiting evaluation).</li> </ul>
<p><b>STIs</b></p>	<ul style="list-style-type: none"> <li>• Women who have current PID, purulent cervicitis, chlamydia, or gonorrhea should not have an IUD <i>inserted</i> (although they are Category 2 for <i>continuation</i> while awaiting evaluation or undergoing treatment). See Textbox 1-2.</li> </ul>

**OVERVIEW OF QUALITY IUD SERVICES**

Figure 1-3 provides an overview of the steps involved in the provision of IUD services, demonstrating the general sequence and scope of care.

Figure 1-3. Flowchart Showing General Steps Involved in IUD Insertion



In considering the figure above, please note the following:

- **Positive or abnormal findings identified through the client assessment may redirect the flow of services.** For illustrative purposes, a purulent cervical discharge, which may indicate gonorrhea or chlamydia, represents the pivotal finding in this flowchart—that is, the finding that “disqualifies” a woman for IUD insertion at this time. (Again, women who have a purulent cervical discharge should not have an IUD inserted until gonorrhea and chlamydia have been ruled out or successfully treated.) There are a few other characteristics and conditions (in addition to purulent cervical discharge) that may be identified through the assessment which can also affect a woman’s eligibility for IUD insertion.
- **The bimanual examination should be performed before the speculum examination for most IUD candidates.** Normally, a speculum examination is completed before the bimanual examination. However, in most potential IUD users, this would mean two speculum insertions (one for the speculum examination; another, after the bimanual examination, for IUD insertion), which can be unpleasant for the woman. The following guidelines have been developed especially for the IUD candidate:
  - If findings from the history and visual inspection are normal (infection is *not* suspected), *perform the bimanual examination first* and the speculum examination second; then, with the speculum still in place, proceed directly to sounding the uterus and IUD insertion.
  - If findings from the history or visual inspection are not normal (infection is suspected), *perform the speculum examination first* and the bimanual examination second. Proceed to sounding the uterus and IUD insertion **only** if appropriate.
- **IUD insertion may immediately follow the speculum examination, provided that the woman is eligible for IUD use at this time.** In many of the settings to which this manual is geared, assessment and IUD insertion will happen at the same visit.
- **Throughout all aspects of care provision, the provider and other health care staff, as appropriate, should adhere to basic principles of quality care, including:**
  - Ensuring that the room/site is adequate for IUD services, and that essential equipment and supplies are available and ready for use.
  - Respecting client rights in all interactions with the woman and her partner.
  - Incorporating education and counseling as appropriate throughout the visit.

## ***Introduction to Intrauterine Contraceptive Devices***

- Incorporating infection prevention practices as appropriate throughout the visit.
- Basing decisions about whether a woman can or can not use an IUD on the latest scientific evidence available, not personal opinion or tradition.
- Providing IUD services based on knowledge, skills, and attitudes that are consistent with the latest scientific evidence available and recommended practices.
- Recognizing when a woman requires services that are beyond the capacity of the provider or the facility to adequately address, and referring her to a higher level of care when needed.

***Introduction to Intrauterine Contraceptive Devices***



## TWO

# FAMILY PLANNING EDUCATION AND COUNSELING

### BACKGROUND

All couples and individuals have a right to make their own decisions about family planning and birth spacing. They also have a right to the accurate, up-to-date information they need to make those decisions responsibly, as well as access to a full range of safe and reliable contraceptive options. Family planning education and counseling play a central role in empowering clients to exercise these and other basic rights (Textbox 2-1), and should be conducted in a manner that aids client choice, and does not persuade, pressure, or induce a person to use a particular method.

**Key objectives** of education and counseling for potential IUD clients are to:

- Provide clients with the information they need to make an informed decision about their reproductive health and contraceptive options;
- Help them select a contraceptive method that is well suited to their individual needs and circumstances, with which they can be satisfied; and
- Provide them with the information they need to use their chosen method safely and effectively.

This chapter provides some basic tips on education but focuses mainly on the counseling process, which includes an educational component. Although counseling may seem time-consuming, it may ultimately save time—and reduce overall costs—by increasing users' satisfaction with and correct use of their contraceptive methods. For potential IUD users, good preinsertion counseling about side effects has been shown to improve continuation rates (Backman et al. 2002; Zetina-Lozano 1983).

Much of the information included here is general, providing a review of key concepts and practices that apply in general family planning education and counseling. Messages that are more relevant or specific to IUD services are highlighted near the end of chapter (starting with Table 2-1, page 2-7), and expanded upon in subsequent chapters where appropriate.

---

In settings where women lack awareness about IUDs or where misinformation about the method is very prevalent, quality education and counseling are critical to overcoming barriers to IUD use.

---

## Family Planning Education and Counseling

### Textbox 2-1. Client Rights<sup>1</sup>

Regardless of ethnic origin, socioeconomic status, religion, marital status, or political beliefs, every member of the community who is of reproductive age should be considered a potential client of family planning services. In providing these services, the health care staff should work together to ensure that the following rights of each client are observed and protected:

**Right to information about family planning:** Family planning programs should assist people in the practice of informed, free choice by providing unbiased information, education, and counseling, as well as an adequate range of contraceptive methods.

**Right to decide which method to use:** Clients should be able to obtain the method they have decided to use, if available and appropriate. The client has the right to decide when to start, stop, or switch methods at any time and for any reason.

**Right to kindness and respect:** Clients also have the right to be treated with kindness, and to discuss their concerns in an environment in which they feel respected, safe, and confident.

**Right to a safe and comfortable environment:** A client should be physically safe and comfortable when receiving family planning services. To a certain extent, this is related to the adequacy of service delivery facilities (e.g., proper ventilation, lighting, seating, toilet facilities). The time the client spends at the facility to receive requested services should be reasonable.

**Right to confidentiality:** The client should be assured that her conversation with a counselor or other service provider is confidential and will not be overheard by other people. She should also know her medical records are secure.

**Right to privacy:** When a client is undergoing a physical examination, it should be carried out in an environment and a manner in which her right to bodily privacy is respected. The client should also be informed of the role of each person in the room (e.g., individuals undergoing training, supervisors, instructors, researchers).

**Right to refuse any examination, procedure, or treatment:** A client should know in advance what is going to be done and why, and has the right to then refuse it.

**Right to appropriate referral and follow-up:** The client has a right to be referred to a higher level of care if any conditions require evaluation or treatment that is beyond the capacity/capability of the facility to provide. A client also has a right to information about any condition requiring referral or follow-up, and about the care that is needed.

**Right to continuity of services:** The services provided to a client should not be discontinued unless a decision to do so is made jointly between the provider and the client. In particular, a client's access to other services should not depend on the continuation or refusal of contraceptive services.

**Right to express her views about services received:** A client's opinions on the quality of services (whether complimentary or negative), together with her suggestions for changes in service provision, should be viewed positively in a program's ongoing effort to monitor, evaluate, and improve its services.

---

<sup>1</sup> Adapted from: Huezo and Briggs 1987.

## **TIPS FOR EFFECTIVE EDUCATION<sup>2</sup>**

Here, education refers to factual information that is shared with clients in a manner that is easy for them to understand, retain, and use. Such information is an important part of all counseling efforts as well, as it helps form the basis of a client's decisions (e.g., about which method to use) and actions (e.g., about how to use the chosen method correctly).

This section presents some tips, collected from counselors over a period of more than 30 years, for providing high-quality education to family planning clients.

- **Engage clients in an activity.** People learn best by actively participating in the learning process, rather than by just listening. For example, you might invite clients to handle a variety of contraceptive methods, or role-play conversations they anticipate having with their partners.
- **Focus on and limit important messages.** Too much information can overwhelm clients and cause them to forget what is most important. Messages should be prioritized so that those that are most important (no more than about three) are given more time and attention.
- **Make sure the timing is right.** People are able to process information better when they are comfortable and relaxed (e.g., *not* during an examination).
- **Continually assess client understanding and retention of information.** Textbox 2-2 describes some methods for enhancing the client's ability to absorb important information.
- **Provide printed materials.** Appropriate printed materials (e.g., client instructions about their chosen method) can both supplement and support educational efforts. Materials should be geared toward both literate and nonliterate clients.

Because many people may be in need of the same basic information about family planning and contraception, education is often conducted in a group setting. This may allow more time for individual counseling, which should be tailored to fit a client's specific needs and circumstances. Depending on the facilitator's level of skill, group education sessions may be very effective. Textbox 2-3 provides tips for conducting group education sessions.

---

<sup>2</sup> Adapted from: Hatcher et al. 2004.

## Family Planning Education and Counseling

### Textbox 2-2. Enhancing Client Understanding/Retention of Information

**Focus**—Ask the client what she already knows about family planning and specific contraceptive methods, and find out which method(s) she is interested in. This helps the provider focus specifically on information the client needs and wants.

**First things first**—Give the most important, “need-to-know” instructions first, that is, what the client must do to use the method safely and effectively.

**Keep it simple**—Use simple, familiar language that the client will understand. Avoid technical terms and scientific explanations.

**Repetition**—Repeat the most important information and instructions several times to reinforce them. Have the client repeat these key messages as well.

**Organization**—Organize information into categories to make it easier to explain and understand. Memory aids, such as acronyms, can help users remember important information. **For IUD users**, warning signs that indicate a need to return to the clinic immediately are reflected in the acronym PAINS (for more information, see Textbox 5-1, page 5-15).

**Specificity**—To be effective, instructions should be concrete and specific, rather than abstract and vague. **For IUD users**, a vague instruction would be: “Return if you have heavy bleeding.” A better, more specific instruction might be: “Return if your menstrual bleeding is more than twice as much or twice as long as usual.”

### Textbox 2-3. Tips for Group Education

Setting up:

- Choose a quiet place with enough space. Avoid places where many people are coming and going.
- Limit groups to 15 people or fewer if possible.
- Seat group members in a circle and sit with them.

Getting started:

- Introduce yourself and have group members introduce themselves.
- Explain the topic and overall purpose of the discussion.
- Help group members feel at ease, perhaps by asking general questions. It helps if you are relaxed as well.
- Start the discussion by presenting clear information. For example, if the purpose of the session is to discuss family planning methods, list them and briefly describe each one.

Throughout:

- Use words that everyone in the group can understand.
- Show samples of family planning supplies when you talk about them. Let group members hold them and look at them.
- Use flipcharts, diagrams, or posters to help illustrate important points.
- Summarize important points often.
- Ask questions frequently to keep group members involved in the discussion. Encourage them to ask questions as well, and to discuss their answers with each other.

Wrapping up:

- Ask for any additional questions.
- Summarize important points.

## TIPS FOR EFFECTIVE COUNSELING

Whereas education refers to the effective communication of factual information, counseling refers to a *discussion*—guided by the provider—that assists the client in considering such information in terms of her own needs and circumstances. Effective counseling assists clients in making decisions that are right for them, which contributes to greater satisfaction with the method chosen, as well as the safe and effective continued use of the method.

Training in counseling and communication techniques can help ensure that service providers are able to provide effective counseling. This section presents some tips for providing quality counseling to family planning clients—highlighting skills, practices, and attitudes that are characteristic of an effective counselor.

---

An effective counselor understands the benefits of counseling and is willing to take the time to do it right.

---

An effective counselor:

- Focuses on the client’s **individual needs and circumstances**.
- Helps the client **make her own decisions** (does not make them for her).
- Uses **good communication skills** throughout:
  - Listens attentively to what the client has to say, using nonverbal gestures, such as nodding, to further encourage her.
  - Asks the client open-ended questions that require more than “yes” or “no” answers to increase the amount of information provided.
  - Encourages the client to ask questions and express her opinions, desires, and concerns.
  - Maintains a friendly tone of voice.
  - Is patient and never pressures the client to finish speaking.
- Demonstrates sensitivity to **cultural, religious, and other psychosocial** factors that affect a woman’s (or a couple’s) decisions around family planning:
  - Keeps in mind that clients may become embarrassed discussing family planning and related issues.
  - Recognizes the potential importance of the partner’s or other family members’ views, and helps the client overcome potential barriers; teaches negotiation skills (e.g., to get her partner to use condoms), if needed.
  - Demonstrates a respectful and nonjudgmental attitude toward the client, no matter what she reveals.
- Maintains a **sound and up-to-date knowledge base** about family planning and a wide range of contraceptive methods.

## **THE COUNSELING PROCESS**

Counseling is not an isolated event but an ongoing process that should be part of every interaction with the client. Family planning counseling can be divided into three phases:

- **General family planning counseling** (during the initial contact with the client): the client is provided basic information on a range of methods and assisted in choosing a method that is appropriate for her;

## ***Family Planning Education and Counseling***

- **Method-specific counseling** (prior to and immediately following provision of the method chosen): the client is provided more detailed information about the method, as well as instructions on how to use it safely and effectively; and
- **Follow-up counseling** (during return visits): the client's satisfaction with the method is assessed, and any problems or concerns are discussed.

The **GATHER** technique is one method used to organize the elements of the counseling process. This acronym is designed to help staff remember important points in an effective counseling session. GATHER is one approach to counseling; in practice, counseling should be tailored to the woman's individual needs and circumstances and thus may follow a different sequence or require other techniques. GATHER means:

- G Greet**
- A Ask**
- T Tell**
- H Help**
- E Explain**
- R Return visit/Refer**

The GATHER technique is outlined in Table 2-1. Points that are specific to or especially relevant to potential IUD clients are **bolded**.

Table 2-1. The GATHER Technique<sup>3</sup>

STEPS	POINTS OF DISCUSSION/ACTIVITIES	RATIONALES
<p><b>GREET</b> the woman</p>	<ul style="list-style-type: none"> <li>● Greet the woman with warmth and respect.</li> <li>● Thank her for coming.</li> <li>● Ask why she has come, and what she hopes to get out of the session.</li> <li>● Make sure she understands that you are here to help <i>her</i> choose a family planning method that is right for her (not choose one for her).</li> <li>● Encourage her to talk and ask questions.</li> <li>● Make clear that you want to listen.</li> <li>● Explain that you need for her to speak openly about some private/personal matters so that you can help.</li> <li>● Assure her that the meeting will be confidential.</li> </ul>	<p>Sets a positive tone</p> <p>Clarifies expectations and roles</p> <p>Lays the foundation for a productive counseling session</p>
<p><b>ASK</b> her about herself</p>	<ul style="list-style-type: none"> <li>● Ask about any previous experiences with family planning (methods used, reason for discontinuing, etc.).</li> <li>● Assess partner/family attitudes about family planning (whether she has discussed this with them, whether they are supportive, etc.).</li> <li>● Ask about her reproductive goals (how many children she wants, desire for birth spacing, <b>desire for long-term protection</b>, etc.).</li> <li>● Ask about her <b>need for protection against STIs</b> (see also Textbox 4-1, page 4-10).</li> </ul> <div style="border: 1px solid black; padding: 5px; margin: 10px 0;"> <p><b>Important:</b> Explain that all sexually active people should consider their individual risk for HIV and other STIs, and whether they should use condoms, alone or along with another method, for protection.</p> </div> <ul style="list-style-type: none"> <li>● Ask whether she is interested in a particular family planning method.</li> </ul>	<p>Provides information you need to assist her in choosing a suitable method</p> <p>Shows client that her needs and desires are important</p>

<sup>3</sup> Adapted from: Gallen, Lettenmaier, and Green 1987.

STEPS	POINTS OF DISCUSSION/ACTIVITIES	RATIONALES
<p><b>TELL</b> her about family planning</p>	<div style="border: 1px solid black; padding: 5px; margin-bottom: 10px;"> <p><b>Tip:</b> Use support materials such as diagrams, brochures, and actual samples of different methods to emphasize and illustrate points. Encourage the woman to handle the materials. <b>Handling a sample IUD may be especially important, as many women may be surprised to see how small it is.</b></p> </div> <ul style="list-style-type: none"> <li>● Provide general information about family planning, focusing on the method in which the woman is interested (if any) and any other methods that may be appropriate. Information covered may include:               <ul style="list-style-type: none"> <li>– Effectiveness of the method</li> <li>– Mechanism of action</li> <li>– Side effects</li> <li>– Health benefits and potential risks</li> <li>– Protection from HIV and other STIs</li> <li>– Cost and convenience</li> <li>– Accessibility/availability of supplies needed</li> <li>– Whatever else may be relevant to the client</li> </ul> </li> </ul> <div style="border: 1px solid black; padding: 5px; margin-left: 350px; margin-top: 10px;"> <p><b>Tip:</b> Tailor information to the woman's desires, as well as to her individual needs and situation—based on what you have learned about her.</p> </div> <p><b>For client messages about the basic attributes of the IUD, see Textbox 2-4.</b></p> <ul style="list-style-type: none"> <li>● Correct any misconceptions the woman may have about the method(s) she is considering. (Ask whether she has any concerns about the method, what she has heard, etc.)</li> </ul> <p><b>For guidance on correcting common misconceptions about the IUD, see Textbox 2-5.</b></p>	<p>Provides information she needs to make an informed decision about which method is suitable for her</p>
<p><b>HELP</b> her select a method</p>	<ul style="list-style-type: none"> <li>● Help the woman choose a method. Do not decide for her.</li> <li>● Assess her knowledge about the selected method by having her repeat key details back to you, and by asking her questions. <b>For potential IUD users, it is especially important that they understand that:</b> <ul style="list-style-type: none"> <li>– <b>Menstrual bleeding pattern changes are a common side effect associated with the method.</b></li> <li>– <b>The IUD offers no protection against HIV or other STIs; clients who are at risk should also use condoms for protection.</b></li> </ul> </li> <li>● Encourage her to ask questions and state any remaining concerns about the selected method.</li> <li>● After a method is selected, the client will undergo the appropriate medical assessment to ensure that there are no medical reasons why she should not use the method. <b>Potential IUD users should know that this will involve a pelvic examination to screen for possible STIs and other conditions.</b></li> <li>● Once the appropriate medical assessment is completed, the chosen contraceptive method is provided, if appropriate. <b>A potential IUD user should know that this will involve a minor procedure to insert the IUD into her uterus.</b></li> <li>● <b>Immediately before the IUD insertion procedure, the client should receive preinsertion counseling (page 5-5).</b></li> </ul>	<p>Helps the woman consider the method(s) discussed in terms of her own needs and circumstances</p> <p>Alerts the potential IUD user to aspects of the method that may be of concern to some women</p> <p>Prepares the potential IUD user for the medical assessment and IUD insertion procedure</p>



STEPS	POINTS OF DISCUSSION/ACTIVITIES	RATIONALES
<p><b>EXPLAIN</b> how to use the method</p>	<ul style="list-style-type: none"> <li>● <b>Immediately after the IUD is inserted, the client should receive postinsertion instructions (page 5-12).</b> <ul style="list-style-type: none"> <li>– Explain how to use the method, what to do if she experiences any problems or side effects, and provide any other basic information needed. <b>For IUD users, special emphasis should be given to menstrual bleeding changes, and the need for condoms to protect against STIs.</b></li> <li>– Provide information on warning signs that indicate the need to return to the clinic immediately. <b>For IUD users, symptoms of infection, expulsion, and pregnancy are among such warning signs.</b></li> <li>– Provide specific return visit instructions. Be sure the woman knows where to go if she has problems, or whom to contact if she has questions. <b>IUD users should have a routine checkup after their first menstruation (in 3 to 6 weeks).</b></li> </ul> </li> <li>● Ask the client to repeat all instructions.</li> <li>● Encourage her to ask questions and state any remaining concerns.</li> <li>● Provide additional information and reassurance as needed.</li> </ul>	<p>Provides information she needs to use the method safely and effectively</p>
<p><b>RETURN VISIT/REFER</b></p>	<ul style="list-style-type: none"> <li>● Assess client satisfaction.</li> <li>● Check for concerns or problems. <b>For IUD users, emphasis is placed on menstrual bleeding changes, use of condoms to protect against STIs, and warning signs. (They also have a pelvic examination to check for infection and expulsion.)</b></li> <li>● Reinforce client instructions for use of the selected method.</li> <li>● Provide appropriate follow-up for any problems identified.</li> <li>● Refer the woman if needed.</li> </ul>	<p>Provides information she needs to continue using (or discontinue using, as appropriate) the method safely and effectively</p>

## Family Planning Education and Counseling

### Textbox 2-4. Client Messages about Basic Attributes of the IUD

Providing correct information about the IUD is a very important component of counseling potential IUD clients, especially in regions where awareness about the method is low or misinformation about the method is prevalent.

<b>What it is</b>	The IUD is a small plastic device that is inserted into a woman's uterus.
<b>Who can use it</b>	Most women can safely use the IUD, including those who are young (or are nulliparous), breastfeeding, HIV-infected, diabetic, and many others. Women who want to use the IUD must undergo a medical assessment with a skilled provider to confirm that they can use the IUD.
<b>Effectiveness</b>	The IUD is more than 99% effective at preventing pregnancy, making it the most effective, reversible contraceptive method currently available.
<b>Mechanism of action</b>	The IUD prevents pregnancy by preventing the sperm from fertilizing the egg.
<b>Course of protection</b>	The IUD begins to work immediately and the Copper T is effective for 12 years.
<b>Side effects</b>	Copper-bearing IUDs (e.g., the Copper T) have fewer side effects than hormonal methods (e.g., the pill), but sometimes cause an increase in the amount, duration, and painfulness of menstrual periods. These symptoms are usually not harmful and often lessen or go away in the first few months after insertion. Use of an NSAID can help.
<b>Health benefits and possible risks</b>	The IUD is very safe and complications, such as expulsion, are uncommon or rare.
<b>Protection from HIV and other STIs</b>	The IUD offers no protection against HIV or other STIs. Only barrier methods (e.g., the condom) help protect against exposure to HIV and other STIs. Women who have a "very high individual risk" for certain STIs should not use the IUD (see also Textbox 4-1, page 4-10).
<b>Cost and convenience</b>	The IUD is relatively inexpensive (an initial cost only) and very convenient (the client has to do nothing). In most cases, only one follow-up visit to the clinic is required.
<b>Accessibility/availability of supplies needed</b>	Once the IUD is inserted, no additional supplies are needed for 12 years (when the IUD will have to be removed/replaced).
<b>Other issues that may be relevant</b>	The IUD can be removed whenever the woman desires, with immediate return to fertility upon removal. IUD insertion and removal require a minor procedure that must be performed by a trained service provider.

**Textbox 2-5. Responding to Rumors and Myths about the IUD**

Addressing false rumors and myths about a given method is an important job for family planning providers. It may be especially critical when counseling potential IUD users, as there are regions where misinformation about the IUD is still very prevalent. When correcting such misinformation, always explain politely *why* it is not true, and explain what *is* true. Be careful not to embarrass the client because s/he has a mistaken idea or belief.

The following are some of the more common rumors/myths about the IUD:

**Rumor/myth:** The IUD might travel through the woman's body, maybe to her heart or her brain.

**Response:** Explain that the IUD usually stays in the uterus until it is removed. If it does come out by itself, it comes out through the vagina. In the rare event that the IUD perforates the uterus (travels through the wall of the uterus) it will remain in the abdomen. An IUD is too big to travel to the heart or to the brain. (Show her a picture or model of the uterus with the IUD in it.)

**Rumor/myth:** IUDs prevent pregnancy by causing abortion.

**Response:** Explain that recent studies show that copper IUDs works by preventing sperm from fertilizing a woman's egg, rather than by destroying a fertilized egg.

**Rumor:** The IUD will interfere with sex.

**Response:** Explain that because the IUD is located in the uterus, not the vaginal canal, neither the woman nor her partner will feel it during sex. It is possible that the partner will feel the strings, but this can be easily corrected if it becomes a problem.

**Rumor/myth:** The IUD may rust inside the woman's body.

**Response:** Explain to the woman that the IUD will not rust inside her body, even after many years.

Additional misconceptions about the IUD are addressed on pages 1-6 to 1-8.



## THREE

# INFECTION PREVENTION<sup>1</sup>

### BACKGROUND

The consistent use of recommended infection prevention practices is another critical component of quality health services, as well as a basic right of every patient, client, or staff member in a health care setting. Although there is only a minimal risk of infection associated with IUD use, studies have shown that it is often related to the insertion procedure (ARHP 2004), rather than to the IUD itself. When the procedure is performed correctly, however, and in accordance with the recommended infection prevention practices, the rate of infection following IUD insertion is very low—less than 1%.

**Key objectives** of infection prevention in providing IUD services are to:

- Reduce the risk of infection due to IUD insertion
- Reduce the risk of disease transmission to IUD clients and potential IUD clients
- Protect health care workers at all levels—from physicians and nurses to housekeeping staff—from disease

The emphasis in this chapter is on infection prevention practices that are practical and feasible for IUD services in any setting. It is meant to act as a review for providers who have already been trained in basic infection prevention principles and processes—providing a general overview of those that apply to general clinical practice, while highlighting and expanding upon those that are relevant or specific to the provision IUD services. Those used in IUD services are also summarized at the end of the chapter (starting on page 3-10).

---

<sup>1</sup> *Adapted from:* Tietjen, Bossemeyer, and McIntosh 2003.

## **OVERVIEW OF INFECTION PREVENTION FOR GENERAL CLINICAL PRACTICE**

### **Key Terms and Definitions**

Terminology related to infection prevention can be confusing. For the purposes of the guidelines presented in these materials, the following key terms and their definitions apply:

- **Microorganisms** are the causative agents of infection. They include bacteria, viruses, fungi, and parasites. In the context of infection prevention, bacteria can be further divided into three categories: vegetative (e.g., staphylococcus), mycobacteria (e.g., tuberculosis), and endospores (e.g., tetanus), which are the most difficult to kill.
- **Asepsis or aseptic technique** is a general term used to describe the combination of efforts made to prevent entry of microorganisms into any area of the body where they are likely to cause infection. The goal of asepsis is to reduce to a safe level, or eliminate, the number of microorganisms on both animate (living) surfaces (e.g., skin and mucous membranes) and inanimate objects (e.g., surgical instruments and other items).
- **Antisepsis** is the prevention of infection by killing or inhibiting the growth of microorganisms on skin and other body tissues by using a chemical agent (antiseptic).
- **Protective barriers** are physical, mechanical, or chemical processes that help prevent the spread of infectious microorganisms from client to client, clinic staff to client, and client to staff. Infection prevention often relies on placing such barriers between the microorganism and the individual. Examples of protective barriers include: handwashing, wearing gloves, using antiseptic solutions, and processing instruments and other items as described below.
- Infection prevention processes that reduce the number of disease-causing microorganisms on instruments, gloves, and other items include the following:
  - **Decontamination** makes inanimate objects that may have come in contact with blood or other body fluids safer to be handled by staff before cleaning (i.e., reduces, but does not eliminate, the number of microorganisms on inanimate objects).
  - **Cleaning** physically removes all visible blood, body fluids, or other material such as dust or dirt from inanimate objects, as well as from skin.
  - **Disinfection** eliminates most, but not all, microorganisms from inanimate objects.

- **High-level disinfection (HLD)**—by boiling, steaming, or use of chemicals—eliminates almost all microorganisms except some bacterial endospores from inanimate objects.
- **Sterilization**—by autoclaving or dry heat—eliminates all microorganisms (bacteria, viruses, fungi, and parasites) including *all* bacterial endospores from inanimate objects.

### Standard Precautions

Transmission-Based Precautions are infection prevention practices that apply only to hospitalized patients (Garner and HICPAC 1996), whereas Standard Precautions are designed for the safety and care of all people in a health care facility—whether a hospitalized patient, a woman receiving IUD services, or a health care worker.

Because many people with bloodborne viral infections (e.g., hepatitis B [HBV], HIV) do not feel or look ill, Standard Precautions are to be applied consistently, regardless of the (known or unknown) health status of those who are providing or receiving care. When applied consistently, Standard Precautions act as protective barriers between microorganisms and individuals, and are considered a highly effective means of preventing the spread of infection. The following considerations and actions help to form such barriers, as well as provide the means for implementing the Standard Precautions:

- **Consider every person** (client or staff) as potentially infectious and susceptible to infection.
- **Wash hands**—the most important procedure for preventing cross-contamination (person to person or contaminated object to person). *In the context of IUD services, hands should be washed before and after conducting the pelvic examination of a potential IUD user, and before and after inserting or removing an IUD.*
- **Wear gloves** (on both hands) before touching anything wet—broken skin, mucous membranes, blood or other body fluids (secretions and excretions), soiled instruments, and contaminated waste materials—or for performing invasive procedures. *In the context of IUD services, gloves are worn during the pelvic examination of a potential IUD user, and before and after inserting or removing an IUD.*
- **Use physical barriers** (protective goggles, face masks, and aprons) if splashes and spills of blood or other body fluids are possible (e.g., when cleaning instruments and other items).
- **Use antiseptic agents** for cleansing skin or mucous membranes before surgery, cleaning wounds, or doing handrubs or surgical handscrubs with an alcohol-based antiseptic product. *In the context*

## **Infection Prevention**

*of IUD services, a water-based antiseptic is applied to the cervix and vagina two or more times before IUD insertion or removal.*

- **Use safe work practices** such as not recapping or bending needles, safely passing sharp instruments, and suturing (when appropriate) with blunt needles.
- **Safely dispose of infectious waste materials** to protect those who handle them and prevent injury or spread of infection to the community.

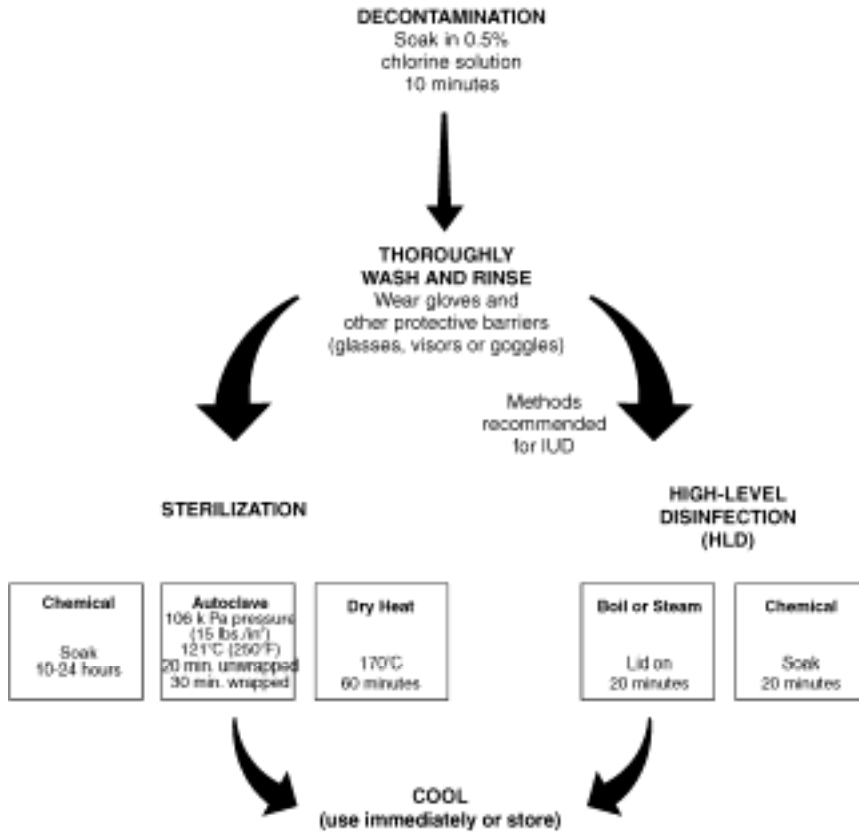
Finally, **process instruments, gloves, and other items** after use by first decontaminating and thoroughly cleaning them, and then either sterilizing or high-level disinfecting them, using recommended procedures. Again, in the context of IUD services, HLD is the recommended method of final processing.

### **Key Infection Prevention Processes**

As shown in Figure 3-1, **decontamination** is the first step in processing soiled (contaminated) instruments, gloves, and other reusable items that may have been in contact with blood or other body fluids (American Association of Operating Room Nurses 1990). Soaking contaminated items briefly in 0.5% chlorine solution, for example, rapidly kills HBV and HIV, thereby making instruments and other items safer to be handled during cleaning. Larger surfaces—such as examination tables and other equipment—may be decontaminated by wiping them down with 0.5% chlorine solution. Guidelines for properly decontaminating items are presented in Textbox 3-2.



Figure 3-1. Processing Surgical Instruments, Gloves, and Other Items<sup>2</sup>



After items have been decontaminated, they should be thoroughly **cleaned** with water and liquid soap or detergent to physically remove organic material such as blood and body fluids (Tietjen and McIntosh 2004). Dried organic material can trap microorganisms in a residue that protects them against HLD or sterilization. Organic matter also can partially inactivate disinfectants, rendering them less effective (Porter 1987). Guidelines for properly cleaning items are presented in Textbox 3-1.

After items have been decontaminated and cleaned, they should be final-processed through **HLD or sterilization** (Tietjen and McIntosh 2004). Although sterilization is generally preferred, it is not necessary for IUD services. This is because mucous membranes are left intact during IUD insertion and removal procedures, and intact mucous membranes are resistant to the subset of common bacterial endospores that only sterilization (and not HLD) can destroy. Therefore, HLD is a safe, effective, and cost-effective method of final processing for IUD services. Guidelines for properly high-level disinfecting (and sterilizing) items are presented in Textbox 3-1. Additional information about HLD is provided in the next section.

<sup>2</sup> Adapted from: WHO 1990.

**Textbox 3-1. General Guidelines for Processing Instruments, Gloves, and Other Items**

**Note:** Staff should wear heavy utility gloves while handling soiled instruments and other items during decontamination and cleaning. These gloves should be discarded if torn or damaged, but can otherwise be cleaned, dried, and reused the next day.

**STEP 1: DECONTAMINATION**

- Immediately after use, fully immerse all **instruments** (e.g., tenaculum, speculum, sound) in a plastic container filled with 0.5% chlorine solution or other locally available disinfectant for 10 minutes. (This step helps prevent transmission of HBV and HIV to staff. It should be done before staff are allowed to handle or clean instruments.)
  - If the instruments will not be cleaned (STEP 2) immediately after decontamination, rinse them with water and dry them with a clean towel to minimize possible corrosion.
- Wipe down all **large surfaces** (e.g., procedure table, instrument stand) that could have been contaminated by blood or other body fluids with a 0.5% chlorine solution.
- While still wearing **gloves** (dispose of waste [STEP 4], if appropriate), briefly immerse both gloved hands in the bucket containing the 0.5% chlorine solution and then carefully remove them by turning them inside out.
  - If disposing of gloves, place them in a leak-proof container (with tight-fitting lid) or plastic bag.
  - If reusing surgical gloves, submerge them in the chlorine solution and soak them for 10 minutes.

**Note:** Appendix A contains detailed instructions on making dilute chlorine solutions for decontamination (and HLD) (pages A-1 to A-3).

**STEP 2: CLEANING AND RINSING**

- After decontaminating **instruments**:
  - a. Thoroughly scrub them under the surface of the water with a soft brush (e.g., a toothbrush) and liquid soap or detergent. Pay special attention to teeth, joints, and screws, where organic material may collect.
  - b. After cleaning, rinse items well to remove all soap or detergent. (This step is important because some detergents can leave a residue that interferes with the action of chemical disinfectants used for HLD [or sterilization].)
  - c. After rinsing, air dry or dry items with a clean towel.
  - d. Once items are dried, proceed with HLD (or sterilization).
- Wash **large surfaces** (e.g., procedure table, instrument stand) with soap and water if organic material remains on them after decontamination.

**Textbox 3-1. General Guidelines for Processing Instruments, Gloves, and Other Items (continued)****STEP 3: HLD (Recommended for IUD Services)**

- After decontaminating (instruments and surgical gloves) and cleaning and rinsing **instruments**, high-level disinfect them using one of the following processes:

**Boil items** for 20 minutes and dry:

- Open or take apart items.
- Fully immerse items in water in a covered pan and heat.
- Bring water to a rolling/bubbling boil, and begin timing.
- Boil for 20 minutes.
- Remove items using high-level disinfected forceps, and place in a high-level disinfected container.
- Allow items to cool and air dry.

Alternatively, **steam items** for 20 minutes and dry.

**Note:** Detailed instructions on steaming gloves are provided in Textbox 3-2.

Alternatively, **soak items in special chemicals** for 20 minutes, rinse, and dry:

- Fully immerse items in an appropriate high-level disinfectant (i.e., 2% glutaraldehyde or 0.1% chlorine solution), prepared as described in Appendix A (page A-5).
- Soak them for 20 minutes.
- Remove items using new/clean examination or high-level disinfected surgical gloves, and high-level disinfected forceps.
- Rinse items three times with boiled and filtered (if necessary) water.
- Place them in a high-level disinfected container and air dry.

**Note:** Appendix A contains detailed information on preparing and using high-level disinfectants (page A-5).

(ALTERNATE) STEP 3: STERILIZATION (Not Essential for IUD Services if HLD Is Available)

- After decontaminating and cleaning and rinsing instruments, sterilize them by autoclave (121°C [250°F] and 106 kPa [15 lb/in<sup>2</sup>] for 20 minutes if unwrapped and 30 minutes if wrapped; or by dry-heat (170°C [340°F] for 60 minutes).

**Note:** Dry-heat sterilization can be used only for metal or glass instruments, not gloves.

**STEP 4: WASTE DISPOSAL**

- After completing a procedure (e.g., IUD insertion or removal), and while still wearing gloves, dispose of **contaminated waste** (e.g., gauze, cotton, disposable gloves) in a properly marked leak-proof waste container (with a tight-fitting lid) or plastic bag.

**STEP 5: STORAGE**

- Use high-level disinfected **instruments** immediately, or store them for up to 1 week in a high-level disinfected container with a tight-fitting cover. (Sterilized instruments not used immediately should be stored in a dry, sterile container with a tight-fitting cover.)
- Use high-level disinfected **gloves** immediately or store them for up to 1 week in a dry, high-level disinfected container with a tight-fitting cover (or in the stacked/covered steamer pans, as described in Textbox 3-2). (Sterilized gloves not used immediately should be stored in a dry, sterile container with a tight-fitting cover.)

**More about High-Level Disinfection**

Because HLD is a safe, effective, and cost-effective method of final processing for IUD services, additional information is provided below about each of the HLD processes: boiling, steaming, and soaking in special chemicals.

### ***HLD by Boiling and Steaming***

For small clinics and those located in remote areas, boiling and steaming are the preferred methods of HLD because they require only inexpensive equipment that is often readily available. There are advantages and disadvantages to both methods.

- An advantage of steaming is that it requires less fuel and thus is more cost-effective than boiling for HLD. Only about 1 liter of water is needed to steam gloves or other instruments, whereas 4 to 5 liters are required for boiling.
- For final processing of surgical gloves, steaming has several additional advantages over boiling. It is less destructive to the gloves, and the gloves are less likely to be contaminated while they are drying after steaming because they remain in the closed steamer pan. Moreover, gloves that have been steamed dry in less time (about 4 hours) than those that have been boiled. Because steaming is the most popular method of processing gloves so that they can be safely reused, detailed instructions on steaming gloves are provided in Textbox 3-2.
- An advantage of boiling is that the pots used can be very large and thus may be more suitable for use with metal instruments. Steaming, on the other hand, may only be practical for processing small items (e.g., surgical gloves, syringes) because locally available steamers are often small.
- Also, the boiling process requires less attention to ensure that it is being done correctly (Salle 1973; Spaulding 1939). By contrast, for steaming to be effective, the bottom pan must contain enough water to continue boiling throughout the steaming process.

### ***HLD by Soaking in Special Chemicals***

Aside from boiling and steaming, the only other method of high-level disinfecting instruments, gloves, and other reusable items is by soaking them in special chemicals. Although a number of disinfectants are commercially available in most countries, only four are approved worldwide for use as high-level disinfectants:

- Chlorine—recommended
- Glutaraldehyde—also recommended
- Formaldehyde (formalin)—no longer recommended (potentially cancer-causing)
- Hydrogen peroxide—rarely used (highly corrosive and unstable)

Important information on the proper preparation, use, and storage requirements for chlorine and glutaraldehyde—the two most commonly used and recommended high-level disinfectants—is presented in Appendix A.

**Important:** Although alcohols and iodophors are inexpensive and readily available disinfectants, they are no longer classified as high-level disinfectants (Rutala 1993). Alcohols do not kill some viruses, and *Pseudomonas* species have been known to multiply in iodophors. **These chemicals should be used for disinfection only when high-level disinfectants are not available or appropriate.**

**Textbox 3-2. How to High-Level Disinfect Surgical Gloves by Steaming**

After gloves have been decontaminated and thoroughly cleaned, they are ready for HLD by steaming.

**STEP 1:** Fold up cuffs of gloves so that they can be put on easily and without contamination after HLD.

**STEP 2:** Place gloves into one of the steamer pans with holes in the bottom. To make removal from the pan after HLD easier, arrange gloves so that cuffs are facing outward, toward the edge of the pan. Five to fifteen pairs can be put in each pan, depending on the diameter of the pan.



**STEP 3:** Repeat this process until up to three steamer pans have been filled with gloves. Stack the filled steamer pans on top of the bottom pan, which contains water for boiling. A second (empty) pan without holes should be placed on the counter next to the heat source (see STEP 9).

**STEP 4:** Place the lid on the top pan and bring water to a full rolling boil. (When water only simmers, very little steam is formed and the temperature may not get high enough to kill microorganisms.)

**STEP 5:** Reduce heat so that water continues to boil at a rolling boil. (When water boils too violently, it evaporates quickly and wastes fuel.)

**Remember:** Be sure there is sufficient water in the bottom pan for the entire 20 minutes of steaming.

**STEP 6:** When steam begins to come out between the pans, start the timer, or note the time on the clock and record it in the HLD log.

**STEP 7:** Steam gloves for 20 minutes.

**STEP 8:** Remove the top steamer pan and place the lid on the top pan remaining in the stack. Gently shake excess water from the gloves in the pan just removed.

**STEP 9:** Place the pan containing gloves on the second (empty) pan (see STEP 3). Repeat until all pans containing gloves are restacked on this empty pan. (This step allows the gloves to cool and dry without becoming contaminated.)

**Remember:** Do *not* place pans containing gloves directly on a table top, counter, or other surface as gloves will be contaminated.

**STEP 10:** Allow gloves to air dry in the steamer pans (4 to 6 hours) before using them.<sup>a</sup>

**STEP 11:** Using a high-level disinfected forceps, transfer the dry gloves to a dry, high-level disinfected container<sup>b</sup> with a tight-fitting lid. Store for up to 1 week. (Gloves also can be stored in the stacked and covered steamer pans.)

<sup>a</sup> Alternatively, allow gloves to cool for 5 to 10 minutes before wearing “wet.” Gloves should be used within 30 minutes, if possible. After this time, the fingers of the gloves stick together and the gloves are hard to put on despite being damp. Gloves that are removed from the steamer pan(s) to be worn “wet” but which are not used during the clinic session should be reprocessed before using.

<sup>b</sup> To prepare a high-level disinfected container, boil (if small) or fill a plastic container with 0.5% chlorine solution and soak for 20 minutes. (The chlorine solution can then be transferred to another container and reused.) Rinse the cover and inside thoroughly with boiled water and allow to air dry.

## **SPECIFIC INFECTION PREVENTION TIPS FOR IUD INSERTION OR REMOVAL**

### **Appropriate Setting**

An examination room in an outpatient clinic or a minor surgery room in a hospital is a suitable setting for IUD insertion or removal. If possible, the room should be located away from heavily used areas of the facility, offer privacy, and:

- Contain an examination or procedure table with a washable surface
- Be adequately lit and well-ventilated (with tight-fitting screens on any open windows)
- Be clean, orderly, and free of dust and insects
- Have tile or concrete floors to facilitate cleaning
- Contain leak-proof containers (with tight-fitting lids) or plastic bags for disposal of contaminated waste items
- Have nearby handwashing facilities, including a supply of clean, running water (i.e., clear, not cloudy or with sediment)

### **Appropriate Attire for Clients and Staff**

Because IUD insertion and removal are minor procedures:

- Clients can wear their own clothing, provided it is clean.
- Staff do not have to wear a cap, mask, or gown.

### **Specific Infection Prevention Measures for the Procedure *Before IUD Insertion or Removal (as Applicable)***

- Ensure that instruments and supplies are available and ready for use.
- Ensure that the IUD package is unopened and undamaged. The IUD package should not be opened until the final decision to insert the IUD has been made.

#### **A Word about Tarnishing**

Sometimes the copper on copper-bearing IUDs tarnishes (i.e., the color darkens), causing concern among providers about the safety and effectiveness of the affected IUD. All available evidence suggests that tarnished IUDs are safe and effective and can be inserted and used in the same way as untarnished IUDs. Therefore, unless the IUD package is torn or opened (or the shelf life has expired), a tarnished IUD is still sterile, safe to use, and effective.

- Have the woman wash (with soap and water) and rinse her perineal area.
- Do not shave her genital area.
- Place a dry, clean cloth between her genital area and the surface of the examination table.

---

**Important:** When insertion is done correctly, the rate of infection following IUD insertion is low—less than 1%; therefore, use of prophylactic antibiotics is **not** recommended (Ladipo et al. 1991; Sinei et al. 1990).

---

- Wash hands thoroughly with soap and water; dry them with a clean, dry cloth or allow them to air dry.
- Put new/clean examination or high-level disinfected (or sterile) surgical gloves on both hands.

### ***During IUD Insertion or Removal (as Applicable)***

- Before sounding the uterus and inserting the IUD (after performing the speculum examination, with the speculum still in place), thoroughly apply a water-based antiseptic (povidone iodine or chlorhexidine) two or more times to the cervix and vagina before beginning the procedure. Cleanse from the inside of the cervical os outward.
  - If povidone iodine is used, allow 1 to 2 minutes before proceeding. Iodophors such as povidone iodine require contact time to act.
  - Do not use alcohol. Alcohol is painful for the woman, and also dries and damages the mucous membranes, which may support the infectious process.
- Load the IUD in its sterile package.
- Throughout the procedure, use the “no-touch” technique to reduce the risk of contaminating the uterine cavity. Using the “no-touch” technique during IUD insertion means that the uterine sound and the loaded IUD:
  - Are not allowed to touch the vaginal walls or the blades of the speculum (or any other nonsterile surface that may contaminate them); and
  - Are not passed through the cervical os more than once.

**Note:** Although mucosa can not be sterilized, antiseptic preparation of the cervix and vagina minimizes the number of microorganisms in the woman’s genital tract. This step is important in reducing the risk of infection following IUD insertion or removal.

***After IUD Insertion or Removal***

- Before removing your gloves:
  - Place all used instruments in 0.5% chlorine solution for 10 minutes for decontamination, if not already done.
  - Dispose of waste materials (e.g., cotton balls) by placing them in a leak-proof container (with tight-fitting lid) or plastic bag.
  - Immerse both gloved hands in 0.5% chlorine solution. Remove gloves by turning them inside out.
    - If disposing of the gloves, place them in the leak-proof container or plastic bag.
    - If reusing the gloves (**not recommended**), submerge them in 0.5% chlorine solution for 10 minutes for decontamination.
- Wash your hands thoroughly with soap and water; dry them with a clean, dry cloth or allow them to air dry.
- After the client has left, wipe the examination table with 0.5% chlorine solution to decontaminate.
- Ensure that all instruments, gloves, and other reusable items are further-processed according to recommended infection prevention practices (Table 3-1).



**Table 3-1. Steps in Processing Instruments, Gloves, and Other Items Used in IUD Services<sup>3</sup>**

<b>INSTRUMENTS/ITEM</b>	<b>DECONTAMINATION</b> (Decontamination is the first step in handling dirty instruments; reduces risk of HBV and HIV transmission.)	<b>CLEANING</b> (Cleaning removes all visible blood, body fluids, and dirt.)	<b>HLD<sup>A</sup></b> (Recommended method of final-processing; HLD destroys all viruses, bacteria, parasites, fungi, and some endospores.)	<b>STERILIZATION<sup>B</sup></b> (Alternative method of final-processing; sterilization destroys all microorganisms, including endospores.)
Examination table top and other large surface areas	Wipe off with 0.5% chlorine solution.	Wash with soap and water if organic material remains after decontamination.	Not necessary.	Not necessary.
Surgical gloves	Soak in 0.5% chlorine solution for 10 minutes before cleaning. Rinse or wash immediately. <sup>c</sup>	Wash with soap and water. Rinse with clean water and check for holes. If to be sterilized, dry inside and out (air or towel dry) and package.	Steam for 20 minutes and allow to air dry in steamer for 4 to 6 hours.	<ul style="list-style-type: none"> <li>• Autoclave at 121°C (250°F), and 106 kPa (15 lbs/in<sup>2</sup>) for 20 minutes.</li> <li>• Do not use for 24 to 48 hours.</li> </ul>
Instruments used in pelvic exam and IUD insertion or removal (e.g., speculum, tenaculum, forceps, uterine sound)	Soak in 0.5% chlorine solution for 10 minutes before cleaning. Rinse or wash immediately. <sup>c</sup>	Using a brush, wash with soap and water. Rinse with clean water. If they will be sterilized, air or towel dry and package.	<ul style="list-style-type: none"> <li>• Steam or boil for 20 minutes.</li> <li>• Chemically high-level disinfect by soaking for 20 minutes. Rinse well with boiled water and air dry before use or storage.</li> </ul>	<ul style="list-style-type: none"> <li>• Dry heat for 1 hour after reaching 170°C (340°F), or</li> <li>• Autoclave at 121°C (250°F) and 106 kPa (15 lbs/in<sup>2</sup>) for 20 minutes (30 minutes if wrapped).</li> </ul>
Storage containers for instruments	Soak in 0.5% chlorine solution for 10 minutes before cleaning. Rinse or wash immediately. <sup>b</sup>	Wash with soap and water. Rinse with clean water, air or towel dry.	Boil container and lid for 20 minutes. If container is too large: <ul style="list-style-type: none"> <li>• Fill container with 0.5% chlorine solution and soak for 20 minutes.</li> <li>• Rinse with water that has been boiled for 20 minutes and air dry before use.</li> </ul>	<ul style="list-style-type: none"> <li>• Dry heat for 1 hour after reaching 170°C (340°F), or</li> <li>• Autoclave at 121°C (250°F) and 106 kPa (15 lbs/in<sup>2</sup>) for 20 minutes (30 minutes if wrapped).</li> </ul>

<sup>a</sup> In the context of IUD services, HLD (as opposed to sterilization) is the recommended method of final-processing.

<sup>b</sup> If unwrapped, use immediately; if wrapped, may be stored up to 1 week before use.

<sup>c</sup> Avoid prolonged exposure (more than 20 minutes) to chlorine solution (more than 0.5%) to minimize corrosion of instruments and deterioration of rubber or cloth products.

<sup>3</sup> Adapted from: Perkins 1983.

***Infection Prevention***

## FOUR

# CLIENT ASSESSMENT

### BACKGROUND

Careful client assessment is necessary to providing quality health care and family planning services. This chapter is not intended to be a comprehensive guide to this important aspect of care provision, but focuses instead on identifying characteristics and conditions that may affect a woman's eligibility for IUD use. If such precautions are identified, the provider and client should weigh any risks posed by the IUD against those posed by unintended pregnancy.<sup>1</sup>

Assessment of potential IUD users should include a focused history and physical examination, including a complete pelvic examination. To ensure that no important element of the assessment is left out, the provider may find it helpful to use a checklist, as presented in Appendix B.

**Note:** This chapter is specific to copper-bearing IUDs.

**Key objectives** of assessment of potential IUD clients are to:

- Ensure that the woman is not pregnant
- Determine the depth and direction of her uterus (for IUD insertion)
- Ensure that she does not have gonorrhea or chlamydia, and is not at very high individual risk of these STIs
- Identify other characteristics or conditions that may affect her eligibility for IUD use
- Identify any other problems that may require further assessment or treatment

---

**Important:** This chapter assumes that the woman has made an informed decision to use the IUD. This means she has been educated about family planning and the different contraceptive options available to her, and has received counseling to help her choose a method that is well suited to her individual needs and circumstances. For more information about family planning education and counseling, see Chapter 2.

---

When conducting the client assessment, the service provider and other health care staff as appropriate should adhere to the **basic principles of quality IUD services**, as described in Chapter 1. Reminders of key practices associated with these principles are integrated throughout the chapter.

---

<sup>1</sup> A woman may visit her health care provider only when she is interested in accessing a particular service, such as having an IUD inserted. Therefore, it may be advisable during this visit to provide general wellness care as well, depending on your skills and resources. Breast examination, cervical cancer screening, and general health education—which are not covered in this chapter—should all be part of an annual well exam.

## **ASSESSMENT**

If not already done:

- Review the woman’s medical records, if available.
- Greet the woman with kindness and respect.
- Confirm that she has been educated and counseled about the IUD, as well as about the insertion procedure.
- Give her a brief overview of the assessment: what it involves, its purpose, etc.
- Ask her whether she has any questions or remaining concerns.
- Provide additional information and reassurance, as needed.

---

**Important:** These guidelines are specific to the screening of potential IUD users. If you find any possible problems or abnormal signs/symptoms (even if they are not “targeted” in this assessment), conduct further evaluation and provide appropriate treatment according to national guidelines/ local protocols (refer if needed).

---

## **History**

### ***Before the History***

- Explain to the woman that it is important for her to speak openly with you so that you can provide her the best care possible.
- Assure her that everything she tells you is confidential.

### ***Conducting the History***

As part of assessment for potential IUD clients, you should conduct a focused history, as outlined below. In most parts of this history, there are specific questions that help target characteristics and conditions that may affect the woman’s eligibility for IUD use (based on the WHO MEC). These questions and their appropriate follow-up are presented in Table 4-1.

- Contraceptive history and reproductive goals:
  - Ask about past experiences with family planning (e.g., methods used, reasons for discontinuing)
  - Ask about desire for children/more children and to space births
  - Ask about desire for long-term contraceptive protection (**H-1**)
- Menstrual history (**Questions H-2 to H-4**):
  - Assess for the possibility of pregnancy (e.g., delayed or missing period, unprotected sex since last menstrual period [LMP])
  - Ask about menstrual patterns (e.g., regular versus irregular cycles, amount and duration of bleeding, pain/cramps)

- **Obstetric history (Questions H-5 to H-8):**
  - Ask about previous pregnancies and births (e.g., how many, when)
  - Ask about previous abortions (e.g., how many, when)
  - Ask about infections following recent births or abortions
- **Medical history (general) (Questions H-9 to H-12):**
  - Ask whether she has been diagnosed with anemia, HIV/AIDS, or valvular heart disease
  - For each known condition, ask about current status, treatment received, etc.
  - Assess for symptoms of anemia
- **Medical history (reproductive) (Questions H-13 to H-17):**
  - Ask whether she has been diagnosed with PID, gonorrhea or chlamydia, or other STIs; cancer of her reproductive organs; trophoblastic disease; or pelvic tuberculosis
  - For each known condition, ask about current status, treatment received, etc.
  - Assess for unexplained vaginal bleeding
  - Assess for symptoms of PID, gonorrhea or chlamydia, or other STIs (e.g., lower abdominal pain, abnormal/purulent vaginal discharge)
  - Assess her individual risk for STIs (e.g., multiple partners, partner with multiple partners, recent STI for her or partner)

## Client Assessment

**Table 4-1. Targeted History and Follow-Up for Potential IUD Users<sup>2</sup>**

QUESTION	NEXT STEPS BASED ON WOMAN'S RESPONSE
H-1. Are you seeking long-term protection against pregnancy?	If YES: Proceed with the assessment  <b>If NO:</b> Consider the woman's need for family planning education and counseling (Chapter 2).
H-2. Are you currently menstruating?  <div style="border: 1px solid black; padding: 5px; width: fit-content;"> <p><b>Remember:</b> An IUD can be inserted at any time during a woman's menstrual cycle, provided you can be reasonably sure she is not pregnant.</p> </div>	If YES: Proceed with the assessment.  <b>If NO:</b> It is possible the woman is pregnant. The IUD should not be inserted unless you can be reasonably sure the woman is not pregnant (by conducting additional assessment below). Having an IUD in place during pregnancy can cause serious uterine infection and spontaneous septic abortion.  <b>What to do:</b> Ask the following questions: <ul style="list-style-type: none"> <li>● Did you have a baby within the last 4 weeks?</li> <li>● Did you have a baby within the last 6 months, are you fully or nearly fully breastfeeding, <b>and</b> have you <b>not</b> had a menstrual period since the birth?</li> <li>● Have you abstained from (<b>not</b> had) sexual intercourse since your LMP or delivery?</li> <li>● Did your LMP start within the <b>last 12 days</b>?</li> <li>● Did you have a miscarriage or abortion in the last 7 days?</li> <li>● Have you been using a reliable contraceptive method consistently and correctly?</li> </ul> <p>→ If the woman answers <b>NO</b> to <i>all questions</i>, she could be pregnant. Advise the woman to await menses to ensure that she is not pregnant before returning to the clinic for possible IUD insertion. Provide a back-up method for her to use during the interim. (Refer also to Textbox 4-3.)</p> <p>→ If the woman answers <b>YES</b> to <i>at least one question</i>, <b>and</b> is free of signs/symptoms of pregnancy, it is very unlikely that she is pregnant. Proceed with the assessment.</p>
H-3a. Have you missed a period?  H-3b. Are you more than 4 weeks postpartum and not fully breastfeeding, <b>and</b> have you not begun menstruating again?	If NO (to both questions): Proceed with the assessment.  <b>If YES (to either question): The IUD should not be inserted</b> unless it can be <i>reliably determined</i> that the woman is not pregnant  <hr/> <p><b>Important:</b> The additional assessment questions for Question H2 do <b>not</b> apply in this situation). Having an IUD in place during pregnancy can cause serious uterine infection and spontaneous septic abortion.</p> <hr/> <b>What to do:</b> Unless it can be <i>reliably determined</i> that the woman is not pregnant, advise the woman to await menses to ensure that she is not pregnant before returning to the clinic for possible IUD insertion. Provide a back-up method for her to use during the interim. (Refer also to Textbox 4-3.)

<sup>2</sup> Adapted from: FHI IUD Checklists (Appendix B); WHO and JHU/CCP 2006; WHO 2004a.

QUESTION	NEXT STEPS BASED ON WOMAN'S RESPONSE
<p>H-4a. Are your menstrual periods very long or heavy, or associated with pain/cramping?</p> <p>H-4b. Have you been told you have endometriosis or severe dysmenorrhea?</p> <div style="border: 1px solid black; padding: 5px; margin-top: 10px;"> <p><b>Note:</b> Unusually heavy or prolonged bleeding may indicate a serious problem; in such cases, the need for further evaluation should be considered.</p> </div>	<p>If NO (to both questions): Proceed with the assessment.</p> <p><b>If YES (to either question):</b> The IUD can generally be used in this situation, but additional care/follow-up may be needed. This is because copper-bearing IUDs may worsen the woman's symptoms/condition.</p> <p><b>What to do:</b></p> <ul style="list-style-type: none"> <li>● Ensure that the woman understands that menstrual changes are a common side effect among IUD users, especially in the first few months, and that they are the main reason women choose to discontinue the method.</li> <li>● If the woman has serious concerns about discomfort, advise her that use of an NSAID (such as paracetamol or ibuprofen) can help lessen symptoms. Ideally, she would also take the medication 30 minutes before the procedure.</li> <li>● If she seems very concerned about the side effects, counsel her on contraceptive methods that may be more appropriate (e.g., hormone-releasing IUDs, such as the Mirena, usually lessen or eliminate such symptoms). Provide the alternative method now, if appropriate (and a back-up method, if needed).</li> </ul> <p><b>Additional support and care</b> (as appropriate after IUD insertion):</p> <ul style="list-style-type: none"> <li>● Emphasize counseling and reassurance for side effects.</li> <li>● Be alert for unusually heavy/prolonged bleeding.</li> </ul>
<p>H-5. Have you ever been pregnant before?</p>	<p>If YES: Proceed with the assessment.</p> <p><b>If NO:</b> The IUD can generally be used in this situation, but additional care/follow-up may be needed. This is because a nulliparous woman may be at increased risk for IUD expulsion if her uterus is less than 6.5 cm in depth (to be determined during uterine sounding, which is done later in the process).</p> <p><b>Additional support and care</b> (as appropriate after IUD insertion):</p> <ul style="list-style-type: none"> <li>● Emphasize counseling about checking for possible IUD expulsion</li> <li>● Be alert for signs/symptoms of IUD expulsion.</li> </ul>
<p>H-6. Did you have a baby 48 hours to less than 4 weeks ago?</p>	<p>If NO: Proceed with the assessment.</p> <p><b>If YES: The IUD should not be inserted at this time.</b> This is because the uterus is rapidly shrinking during this time period, which may increase the risk of uterine perforation during IUD insertion. <i>Note that the IUD can generally be inserted within 48 hours of birth, provided there is no evidence of infection; but this procedure should be performed only by a specially trained provider.</i></p> <p><b>What to do:</b></p> <ul style="list-style-type: none"> <li>● If birth 48 hours to less than 4 weeks ago, advise the woman to return to the clinic for possible IUD insertion at 4 weeks. Provide a back-up method for her to use during the interim (if any doubt she will return at 4 weeks). (Refer also to Textbox 4-3.)</li> <li>● If birth less than 48 hours ago, and you are not specially trained to perform this procedure:             <ul style="list-style-type: none"> <li>- Refer the woman to a qualified provider; or</li> <li>- Advise the woman to return to the clinic for possible IUD insertion at 4 weeks; provide a back-up method for her to use during the interim (if any doubt she will return at 4 weeks). (Refer also to Textbox 4-3.)</li> </ul> </li> </ul>

**Client Assessment**

QUESTION	NEXT STEPS BASED ON WOMAN'S RESPONSE
<p>H-7. Did you have a miscarriage or abortion within the last 4 weeks?</p>	<p>If NO: Proceed with the assessment.</p> <p><b>IF YES:</b> The IUD can be inserted immediately following (or within 7 days of) a first-trimester spontaneous or induced abortion, provided there is no evidence of infection. <i>Note that the IUD can generally be inserted immediately following a spontaneous or induced second-trimester abortion, provided there is no evidence of infection; but this procedure should be performed only by a specially trained provider.</i></p> <p><b>What to do:</b></p> <ul style="list-style-type: none"> <li>● If immediately following a first-trimester abortion, screen the woman carefully for evidence of infection (as in Question H-8 and the pelvic examination). Determine the appropriate action based on findings.</li> <li>● If immediately following a second-trimester abortion, and you have not been specially trained to perform this procedure:               <ul style="list-style-type: none"> <li>– Refer the woman to a qualified provider; or</li> <li>– Advise the woman to return to the clinic for possible IUD insertion at 4 weeks; provide a back-up method for her to use during the interim (if any doubt she will return at 4 weeks). (Refer also to Textbox 4-3.)</li> </ul> </li> </ul>
<p>H-8. Have you been told you have an infection—or do you have symptoms of infection (such as fever, chills, abnormal discharge)—within 6 weeks of birth or immediately following abortion?</p>	<p>If NO: Proceed with the assessment.</p> <p><b>IF YES: The IUD should not be inserted at this time.</b> This is because an IUD may substantially worsen puerperal sepsis or post-septic abortion.</p> <p><b>What to do:</b></p> <ul style="list-style-type: none"> <li>● Advise the woman that IUD insertion can be reconsidered once her infection has been successfully treated.</li> <li>● Strongly recommend the use of condoms while undergoing treatment.</li> <li>● Conduct further evaluation and provide appropriate treatment according to national guidelines/local protocols (refer if needed). (Refer also to Textbox 4-3.)</li> </ul>
<p>H-9. Do you have anemia, or symptoms of anemia (such as fatigue, weakness, dizziness, headache, ringing in ears, sore tongue, irritability)?</p>	<p>If NO: Proceed with the assessment.</p> <p><b>IF YES:</b> The IUD can generally be used in this situation, but additional care/follow-up may be needed. This is because copper-bearing IUDs may increase menstrual bleeding.</p> <p><b>What to do:</b></p> <p>If the woman has anemia (known or suspected), screen the woman for other evidence of this condition (as in Question PE-1). Determine the appropriate action based on findings.</p>



QUESTION	NEXT STEPS BASED ON WOMAN'S RESPONSE
<p>H-10. Have you been told you have a heart disease or a condition that affects your heart valves?</p>	<p>If NO: Proceed with the assessment.</p> <p><b>If YES:</b> The IUD can generally be used in this situation; appropriate action depends on whether she has complicated/symptomatic valvular heart disease. If she does, additional care/follow-up may be needed because there may be an increased risk of infection (endocarditis) related to IUD insertion.</p> <p><b>What to do:</b></p> <ul style="list-style-type: none"> <li>● Assess whether her valvular heart disease is complicated/symptomatic (e.g., cardiopulmonary shunts or artificial heart valves, history of rheumatic heart disease or subacute bacterial endocarditis, pulmonary hypertension, on anti-coagulant treatment).</li> <li>● If complicated/symptomatic valvular heart disease, provide prophylactic antibiotics before IUD insertion (or removal): <ul style="list-style-type: none"> <li>– If the woman is at <b>high risk</b> (e.g., has an artificial heart valve), she should receive IV antibiotic treatment per national guidelines/local protocols.</li> <li>– If the woman is at <b>moderate risk</b> (e.g., has rheumatic heart disease), consider antibiotic treatment per national guidelines/local protocols.</li> </ul> </li> </ul>
<p>H-11. Do you have HIV?</p>	<p>If NO: Proceed with the assessment.</p> <p><b>If YES:</b> The IUD can generally be used in this situation, provided that the woman is clinically well, with access to adequate care. Additional care/follow-up may be needed because the IUD provides no protection against HIV reinfection or other STIs.</p> <p><b>What to do:</b> Assess whether she is clinically well (e.g., has not been feeling ill, has not been diagnosed with AIDS) and has access to adequate care.</p> <ul style="list-style-type: none"> <li>● If she is clinically well with access to adequate care: <ul style="list-style-type: none"> <li>– Remind her that the IUD offers no protection against STIs or HIV reinfection.</li> <li>– Urge her to use condoms in addition to the IUD.</li> </ul> </li> <li>● If she is not clinically well, advise her that the IUD is not recommended for women in this situation. Help her choose a different method. (Refer also to Textbox 4-3.)</li> </ul> <p><b>Additional support and care</b> (as appropriate after IUD insertion):</p> <ul style="list-style-type: none"> <li>● Continue to urge use of condoms.</li> <li>● Be alert for signs/symptoms of pelvic infection and other problems.</li> </ul>

**Client Assessment**

QUESTION	NEXT STEPS BASED ON WOMAN'S RESPONSE
<p>H-12. Do you have AIDS?</p>	<p>If NO: Proceed with the assessment.</p> <p><b>If YES:</b> The IUD often can generally be used in this situation, provided that the woman is on ARV therapy <u>and</u> is clinically well, with access to adequate care. Additional care/follow-up may be needed because the IUD provides no protection against HIV reinfection or other STIs.</p> <p><b>What to do:</b> Assess whether she is on ARV therapy <u>and</u> is clinically well (e.g., has not been feeling ill, does not have opportunistic infections) and has access to adequate care.</p> <ul style="list-style-type: none"> <li>● If she is on ARV therapy <u>and</u> is clinically well, with access to adequate care: <ul style="list-style-type: none"> <li>- Remind her that the IUD offers no protection against STIs or HIV reinfection.</li> <li>- Urge her to use condoms in addition to the IUD.</li> </ul> </li> <li>● If she is not on ARV therapy (regardless of whether she is clinically well or has access to care), advise her that the IUD is not recommended for women in this situation. Help her choose a different method. (Refer also to Textbox 4-3.)</li> </ul> <p><b>Additional support and care</b> (as appropriate after IUD insertion):</p> <ul style="list-style-type: none"> <li>● Continue to urge use of condoms.</li> <li>● Be alert for signs/symptoms of pelvic infection and other problems.</li> </ul>
<p>H-13. Have you been told you have any of the following?</p> <ul style="list-style-type: none"> <li>● Cancer of your reproductive organs</li> <li>● Pelvic tuberculosis</li> <li>● Trophoblastic disease</li> </ul>	<p>If NO: Proceed with the assessment.</p> <p><b>If YES: The IUD should not be inserted.</b> This is because an IUD may increase the risk of infection or perforation in the presence of these conditions, and/or worsen these conditions. (Note: While women with cancer of the reproductive organs should not have an IUD inserted, they may often continue the method [keep an IUD already in place] while awaiting evaluation.)</p> <p><b>What to do:</b> Advise her that the IUD should not be used by women in this situation. Help her choose a different method. (Refer also to Textbox 4-3.)</p>
<p>H-14. Have you been diagnosed with any of the following within the last 3 months or so?</p> <ul style="list-style-type: none"> <li>● PID</li> <li>● Gonorrhea or chlamydia</li> <li>● Purulent cervicitis</li> <li>● Another STI</li> </ul> <div style="border: 1px solid black; padding: 5px; margin-top: 10px;"> <p><b>Remember:</b> While women with PID, gonorrhea or chlamydia, or purulent cervicitis should not have an IUD inserted, they may continue the method (if already in place when the infection develops) while undergoing treatment if so desired.</p> </div>	<p>If NO: Proceed with the assessment.</p> <p><b>If YES: The IUD should not be inserted</b> until current gonorrhea and chlamydia have been reliably ruled out or successfully treated. Recent diagnosis with any of these infections makes the woman at “very high individual risk” for current infection. In women with PID, the IUD may worsen the condition; in women with gonorrhea or chlamydia, the IUD may increase the risk of PID. (Note: If the woman has past PID with a subsequent pregnancy, she can have an IUD inserted, assuming there are known current risk factors for STIs. Current risk is assessed in Question H-17a and b.)</p> <p><b>What to do:</b> Advise the woman that IUD insertion can be reconsidered once current gonorrhea and chlamydia have been reliably ruled out or successfully treated. Follow the steps in Textbox 4-2.</p>

QUESTION	NEXT STEPS BASED ON WOMAN'S RESPONSE
<p>H-15. Do you have, or have you recently had, either of the following?</p> <ul style="list-style-type: none"> <li>• Vaginal bleeding that is unusual for you (e.g., between your periods)</li> <li>• Vaginal bleeding that occurs after intercourse</li> </ul>	<p>If NO: Proceed with the assessment.</p> <p><b>IF YES: The IUD should not be inserted.</b> Bleeding that is unusual for the woman or that occurs after intercourse suggests an underlying problem that should be promptly evaluated.</p> <p><b>What to do:</b></p> <ul style="list-style-type: none"> <li>• Advise the woman that further evaluation is needed to find the cause of her symptoms before IUD insertion can be reconsidered.</li> <li>• Urge the use of condoms in the interim, or provide another back-up method.</li> <li>• Conduct further evaluation and provide appropriate treatment according to national guidelines/local protocols (refer if needed).</li> </ul> <p>(Refer also to Textbox 4-3.)</p>
<p>H-16. Do you have, or have you recently had, <b>either</b> of the following:</p> <ul style="list-style-type: none"> <li>• Lower abdominal pain (that may be worse during/after intercourse or when walking), accompanied by fever or chills</li> <li>• Abnormal vaginal discharge that may contain pus</li> </ul>	<p>If NO (to both): Proceed with the assessment.</p> <p><b>If YES (to either):</b> These symptoms may indicate PID, gonorrhea or chlamydia, or another STI.</p> <p><b>What to do:</b> Screen the woman carefully for evidence of current infection (as in Question H-17a and b and the pelvic examination). Determine the appropriate action based on findings.</p>
<p>H-17a. Have you had any of the following in the last 3 months or so:</p> <ul style="list-style-type: none"> <li>• More than one sexual partner (without consistently using condoms)</li> <li>• STI diagnosis</li> </ul> <p>H-17b. Has a sexual partner had any of the following in the last 3 months or so?</p> <ul style="list-style-type: none"> <li>• Symptoms of STI (such as pus coming from his penis, pain or burning on urination, an open sore in the genital area) <ul style="list-style-type: none"> <li>- More than one sexual partner (without consistently using condoms)</li> <li>- STI diagnosis</li> </ul> </li> </ul> <div style="border: 1px solid black; padding: 5px; margin-top: 10px;"> <p><b>Note</b> that women who are at risk for STIs other than gonorrhea and chlamydia (e.g., herpes, syphilis, HIV, HBV) can generally have an IUD inserted.</p> </div>	<p>If NO: Proceed with the assessment.</p> <p><b>If YES: The IUD should not be inserted</b> until current gonorrhea and chlamydia have been reliably ruled out or successfully treated. The presence of <i>any of these factors</i> suggests that the woman is at “very high individual risk” for current infection with gonorrhea or chlamydia. In women with gonorrhea or chlamydia, the IUD may increase the risk of PID.</p> <p><b>What to do:</b> Advise the woman that IUD insertion can be reconsidered once current gonorrhea and chlamydia have been reliably ruled out or successfully treated. Follow the steps in Textbox 4-2.</p> <hr/> <p><b>Important:</b> The provider should not base his/her assessment of whether a woman is at “very high individual risk” for gonorrhea or chlamydia on local STI prevalence rates. The questions in the left column are intended to help identify factors that place an <i>individual</i> woman at <i>very high risk</i> for these STIs. This approach may be limited, however, given that there is no universal set of questions that can identify all such women, and women may be reluctant to discuss these matters openly. Thus, providers may wish to consider an alternative approach to this critical component of assessment for potential IUD users, as shown in Textbox 4-1.</p> <hr/>

**Textbox 4-1. Self-Assessment Tool for “Very High Individual Risk” of Gonorrhea or Chlamydia<sup>3</sup>**

This approach to identifying women who are at “very high individual risk” of gonorrhea or chlamydia is based on the notion that the woman is often the best judge of whether she is at risk—assuming she has the accurate, up-to-date information she needs to make this determination. The following steps are intended to guide the provider in assisting a woman through this “self-assessment” process. Throughout this process, the provider should make clear that the woman does not have to share any information regarding her or her partner’s sexual behaviors.

- 1. Explain that having an IUD inserted is not recommended for women who are at very high individual risk for certain STIs (gonorrhea or chlamydia). Explain why.**
- 2. Tell her that you are going to list some possibly risky situations that—if they have occurred recently in a woman’s life—would place her at very high individual risk for these STIs (gonorrhea or chlamydia).** Encourage the woman to consider these situations carefully in assessing her own risk and the possibility of having an STI. Possibly risky situations\* include any of the following (especially within the last 3 months or so):
  - A sexual partner has recently had STI symptoms such as pus coming from his penis, pain or burning during urination, or an open sore in the genital area.
  - She or a sexual partner was diagnosed with an STI recently.
  - She has had more than one sexual partner recently.
  - She has a sexual partner who has had other partners recently.You can also mention any other high-risk situations that may exist locally. For example, if men in the community who work away from home for long periods of time often return with STIs, you might add, “She has a sexual partner who works away from home for long periods of time.”
- 3. Ask the woman whether, after considering these risky situations, she thinks the IUD is an appropriate choice for her, or whether she would like to consider other contraceptive methods.**
  - If the woman does not think the IUD is an appropriate choice for her, or would like to consider other contraceptive methods:
    - Counsel her on contraceptive methods that may be more appropriate.
    - Urge the use of condoms, alone or with another method, to protect against STIs.
    - Provide the alternative method now, if appropriate (and a back-up method, if needed).
    - Consider the need for further evaluation/treatment (if current STI is suspected). (Refer also to Textbox 4-3.)
  - If the woman still wants to use the IUD, but you have strong reason to believe that she is at “very high individual risk” for gonorrhea or chlamydia, advise her that IUD insertion can be reconsidered once current gonorrhea and chlamydia have been reliably ruled out or successfully treated. Follow the steps in Textbox 4-2.

\* These situations pose less risk if a woman or her partner uses condoms consistently and correctly.

## **Physical Examination**

### ***Before the Examination***

- Ensure that essential equipment and supplies are available and ready for use.
- Ensure that the woman has recently emptied her bladder.
- Have her wash (with soap and water) and rinse her perineal area, if possible.
- Help her onto the examination table.
- Assure her that you will do your best to make the examination as comfortable as possible.

<sup>3</sup> Adapted from: WHO and JHU/CCP 2006.

- Advise her to tell you if she feels any pain at any time.
- Wash your hands thoroughly with soap and water; dry them with a clean, dry cloth or allow them to air dry.

**During the physical examination** (and IUD insertion or removal procedures):

- Keep the woman informed of what you are doing.
- Use gentle, careful movements when touching her. Avoid sudden or unexpected movements.
- Use the drape to cover parts that are not directly involved in the examination or procedure (e.g., while you are examining the woman's abdomen, her genitalia should be covered).

**Performing the Physical Examination**

As part of assessment for potential IUD clients, you should conduct a focused physical examination (including a complete pelvic examination), as outlined below. In each part of the exam, there are specific questions that help target characteristics and conditions that may affect the woman's eligibility for IUD use (based on the WHO MEC). These questions and their appropriate follow-up are presented in Table 4-2.

Check for signs of anemia (**Question PE-1**):

- Pallor of skin, conjunctiva (insides of eyelids), or nailbeds
- Brittle nails
- Rapid pulse (more than 100 beats/minute)

Perform an abdominal examination:

- Check for suprapubic or pelvic tenderness.
- Check for swellings, bulges, masses or gross abnormalities.

Perform a pelvic examination:

- Inspect the external genitalia and urethral opening (**Question PE-2**).
  - Check for ulcers, lesions, and sores.
  - Check for buboes (enlarged groin nodes).
  - Palpate the Skene's and Bartholin's glands, checking for tenderness or discharge.

---

**Important:** Normally, a speculum examination is completed before the bimanual examination. However, in most IUD candidates, this would mean two speculum insertions (one for the speculum examination; another, after the bimanual examination, for IUD insertion), which can be unpleasant for the woman. The following guidelines have been developed especially for the IUD candidate:

- **If findings from the history and visual inspection are normal** (infection is *not* suspected), perform the **bimanual examination first** and the **speculum examination second**; then, with the speculum still in place, proceed directly to sounding the uterus and IUD insertion.
  - **If findings from the history or visual inspection are not normal** (infection is suspected), perform the **speculum examination first** and the **bimanual examination second**. Proceed to sounding the uterus and IUD insertion only if indicated.
- 

- Perform a bimanual examination (before the speculum exam only if infection is *not* suspected) (**Questions PE-3 to PE-6**):
  - Determine size, shape, and position of uterus.
  - Check for enlargement or tenderness of the adnexa and cervical motion tenderness.
  - Check for uterine abnormalities that may interfere with proper placement of the IUD, such as a malformed uterus or uterine fibroids that distort the shape of the uterus.
- Perform a speculum examination of the vagina and cervix (**Questions PE-7 to PE-9**):
  - Check for purulent vaginal or cervical discharge (cervicitis).
  - Check for ulcers, lesions, and sores.
  - Check cervix for bleeding, erosions, or narrowing of cervical canal (stenosis).
- If findings from the bimanual examination are unclear (e.g., position or size of uterus not determined), perform a rectovaginal examination:
  - Determine size, shape, and position of uterus.
  - Check for cul-de-sac mass or tenderness.

Table 4-2. Targeted Physical Examination and Follow-Up for Potential IUD Users<sup>4</sup>

QUESTION	NEXT STEPS BASED ON FINDINGS
PE-1. Does she have signs of anemia?	<p>If NO: Proceed with the assessment.</p> <p><b>IF YES:</b> The IUD can generally be used in this situation, but additional care/follow-up may be needed. This is because copper-bearing IUDs may increase menstrual bleeding.</p> <p><b>What to do:</b></p> <ul style="list-style-type: none"> <li>● If available, do a hemoglobin/hematocrit test. (Hb less than 7 gm/dl or Hct less than 20 indicates severe anemia.)</li> <li>● If the woman has mild to moderate anemia (known or suspected): <ul style="list-style-type: none"> <li>– Prescribe iron folate according to national guidelines/local protocols.</li> <li>– Counsel on local, iron-rich foods.</li> </ul> </li> <li>● If the woman has severe anemia (known or suspected), counsel her on contraceptive methods that may be more appropriate. Provide the alternative method now, if appropriate (and back-up method, if needed).</li> </ul> <p><b>Additional support and care</b> (as appropriate after IUD insertion):</p> <ul style="list-style-type: none"> <li>● Continue iron folate and nutritional counseling.</li> <li>● Be alert for increase in amount/duration of menstrual bleeding.</li> <li>● Be alert for signs/symptoms of worsening anemia.</li> </ul>
<p>PE-2. Are there ulcers on the vulva, vagina, or cervix?</p> <div style="border: 1px solid black; padding: 5px; margin-top: 10px;"> <p><b>Note</b> that women who have STIs other than gonorrhea and chlamydia (e.g., herpes, syphilis, HBV) can generally have an IUD inserted.</p> </div>	<p>If NO: Proceed with the assessment.</p> <p><b>If YES: The IUD should not be inserted</b> until current gonorrhea and chlamydia have been reliably ruled out or successfully treated. These symptoms indicate possible STI.</p> <p><b>What to do:</b> Advise the woman that IUD insertion can be reconsidered once current gonorrhea and chlamydia have been reliably ruled out or successfully treated. Follow the steps in Textbox 4-2.</p>
PE-3. Are there uterine fibroids or an anatomical abnormality that distorts the shape of the uterus?	<p>If NO: Proceed with the assessment.</p> <p><b>If YES: The IUD should not be inserted.</b> This is because this condition may prevent proper placement of the IUD.</p> <p><b>What to do:</b> Advise her that the IUD should not be used by women in this situation. Help her choose a different method. (Refer also to Textbox 4-3.)</p>
PE-4. Were you unable to determine the size and position of the uterus?	<p>If NO: Proceed with the assessment.</p> <p><b>If YES: The IUD should not be inserted.</b> This is because the provider must know the size and position of the uterus in order to safely insert and properly place the IUD.</p> <p><b>What to do:</b> Advise her that the IUD should not be used by women in this situation. Help her choose a different method. (Refer also to Textbox 4-3.)</p>

<sup>4</sup> Adapted from: FHI IUD Checklists (Appendix B); WHO and JHU/CCP 2006; WHO 2004a.

## Client Assessment

QUESTION	NEXT STEPS BASED ON FINDINGS
<p>PE-5. Does the client feel pain when you move the cervix (cervical motion tenderness)?</p>	<p>If NO: Proceed with the assessment.</p> <p>If YES: <b>The IUD should not be inserted</b> until current gonorrhea and chlamydia have been reliably ruled out or successfully treated. This symptom indicates possible PID.</p> <p><b>What to do:</b> Advise the woman that IUD insertion can be reconsidered once current gonorrhea and chlamydia have been reliably ruled out or successfully treated. Follow the steps in Textbox 4-2.</p>
<p>PE-6. Is there pain in the uterus, ovaries, or fallopian tubes (adnexal tenderness)?</p>	<p>If NO: Proceed with the assessment.</p> <p>If YES: <b>The IUD should not be inserted at this time.</b> These symptoms indicate possible PID or another problem.</p> <p><b>What to do:</b></p> <ul style="list-style-type: none"> <li>● Advise the woman that further evaluation is needed to find the cause of her symptoms before IUD insertion can be reconsidered.</li> <li>● Urge the use of condoms in the interim.</li> <li>● Conduct further evaluation and provide appropriate treatment according to national guidelines/local protocols (refer if needed).</li> </ul> <p>(Refer also to Textbox 4-3.)</p>
<p>PE-7. Are there cervical lacerations or narrowing of the cervical canal (stenosis)?</p>	<p>If NO: Proceed with the assessment.</p> <p><b>IF YES:</b> The IUD can generally be used in this situation, but there may be some difficulties inserting the IUD.</p>
<p>PE-8. Is there purulent cervical discharge (cervicitis)?</p>	<p>If NO: Proceed with the assessment.</p> <p>If YES: <b>The IUD should not be inserted</b> until current gonorrhea and chlamydia have been reliably ruled out or successfully treated. These symptoms indicate possible PID or STI.</p> <p><b>What to do:</b> Advise the woman that IUD insertion can be reconsidered once current gonorrhea and chlamydia have been reliably ruled out or successfully treated. Follow the steps in Textbox 4-2.</p>
<p>PE-9. Does the cervix bleed easily when touched?</p>	<p>If NO: Proceed with the assessment.</p> <p>If YES: <b>The IUD should not be inserted at this time.</b> These symptoms indicate possible STI or another problem.</p> <p><b>What to do:</b></p> <ul style="list-style-type: none"> <li>● Advise the woman that further evaluation is needed to find the cause of her symptoms before IUD insertion can be reconsidered.</li> <li>● Urge the use of condoms in the interim, or provide another back-up method.</li> <li>● Conduct further evaluation and provide appropriate treatment according to national guidelines/local protocols (refer if needed).</li> </ul> <p>(Refer also to Textbox 4-3.)</p>



**Textbox 4-2. Support and Care for Women Who Might Have Gonorrhea or Chlamydia**

Women who might have gonorrhea or chlamydia (based on the assessment) should not have an IUD inserted at this time. Follow these guidelines to provide appropriate support and care for women in this situation.

1. Inform the woman that she might have gonorrhea or chlamydia, and advise her that these conditions will have to be ruled out or successfully treated before IUD insertion can be reconsidered. (**Remember** that women with STIs other than gonorrhea and chlamydia [e.g., herpes, syphilis, HBV] can generally have an IUD inserted.)
2. Urge her to have her partner(s) come to the clinic for testing/treatment as well. Explain that unless her partner receives treatment, she is very likely to become reinfected.
3. Conduct further evaluation and provide treatment as shown below (according to national guidelines/local protocols); refer, if needed:

**If STI testing is available:**

- Test the woman and her partner to diagnose or rule out gonorrhea or chlamydia.
- If results are positive:
  - Advise the woman that she can have an IUD inserted when her infection is cured.
  - Treat the woman and her partner(s).
  - Provide a back-up method for them to use while undergoing treatment (strongly recommend the use of condoms).
  - Arrange for a follow-up visit.
  - Insert the IUD as soon as the infection is cured.
  - Advise the woman to return to the clinic **immediately** if she develops lower abdominal pain or unusual vaginal discharge with fever.
  - Be alert for signs of infection during follow-up visits.
- If results are negative, she can have an IUD inserted.

**If STI testing is not available:**

- Consider presumptive treatment of the woman and her partner(s).
- If presumptive treatment is not available, or the woman and her partner do not wish to be treated:
  - Make clear that inserting an IUD is usually not recommended for women in this situation.
  - Discuss other, more appropriate contraceptive methods. Help her choose a different method, if appropriate.
  - If no other method is available or acceptable to the woman, insert the IUD.
  - Advise the woman to return to the clinic **immediately** if she develops lower abdominal pain or unusual vaginal discharge with fever.
  - Be alert for signs of infection during follow-up visits.

**NEXT STEPS**

After determining whether the woman is a good candidate for IUD use, perform the following steps as appropriate:

- If the woman is a suitable candidate for IUD insertion at the time, provide the IUD now, as appropriate (Chapter 5).
- If there is a problem or reason to withhold IUD insertion temporarily (e.g., until the next menses if pregnancy can not be ruled out) or permanently (e.g., as in the case of severe uterine anomalies), follow the steps in Textbox 4-3.

## **Client Assessment**

### **Textbox 4-3. What to Do if the Woman Is Not Currently Eligible for IUD Use**

#### **Always:**

- Provide clear information on why the IUD is being withheld (either temporarily or permanently).
- Explain any further evaluation or treatment that is needed.
- Conduct further evaluation and provide treatment according to national guidelines/local protocols (refer, if needed), as appropriate.

#### **If the IUD is being temporarily withheld:**

- Ensure that the woman understands exactly what needs to happen before the IUD can be reconsidered (e.g., menstruation, in the case of suspected pregnancy; successful treatment, in the case of infection).
- Provide a back-up method\* to use in the interim.
- Schedule a follow-up appointment for reassessment.

#### **If the IUD is being permanently withheld:**

- Discuss other, more appropriate contraceptive methods.
- Help her choose one that is well suited to her needs and situation.
- Provide the alternative method now, if possible. (Provide a back-up method\*, if needed.)
- Schedule a follow-up appointment, as appropriate.

\* Back-up methods include abstinence, male and female condoms, spermicides, and withdrawal. Spermicides and withdrawal are the least effective methods. (If possible, give the woman condoms.)

## FIVE

# IUD INSERTION AND REMOVAL

### BACKGROUND

IUD insertion and removal should be performed only by clinicians (physicians, nurses, and midwives) who have been trained to perform these procedures. Problems associated with IUDs (e.g., IUD expulsion, infection, uterine perforation) are uncommon, but when they do occur, they are often due to improper insertion technique.

**Note:** This chapter is specific to the Copper T IUD.

Although IUD insertion and removal procedures are relatively simple, they are made up of several, discrete steps to be performed in a specific sequence, as detailed in this chapter. These steps must be integrated with the appropriate infection prevention and counseling measures to help ensure the safety and well-being of the woman. Appropriate client assessment and care are also essential components of IUD insertion and removal services.

**Key objectives** of IUD insertion and removal services are to:

- Perform IUD insertion and removal procedures properly in a manner that is safe and as comfortable as possible for the woman
- Provide the woman with information she needs to ensure safe and effective use of the IUD (or to discontinue the method/switch to another method, if appropriate)

---

**Important:** This chapter assumes that the woman has undergone a complete client assessment, as described in Chapter 4, and is eligible for IUD insertion at this time.

---

When conducting IUD insertion and removal, the service provider and other health care staff as appropriate should adhere to the **basic principles of quality IUD services**, as described in Chapter 1. Reminders of key practices associated with these principles are integrated throughout the chapter.

## **ESSENTIAL SUPPLIES**

### **Instruments, Gloves, and Other Key Items**

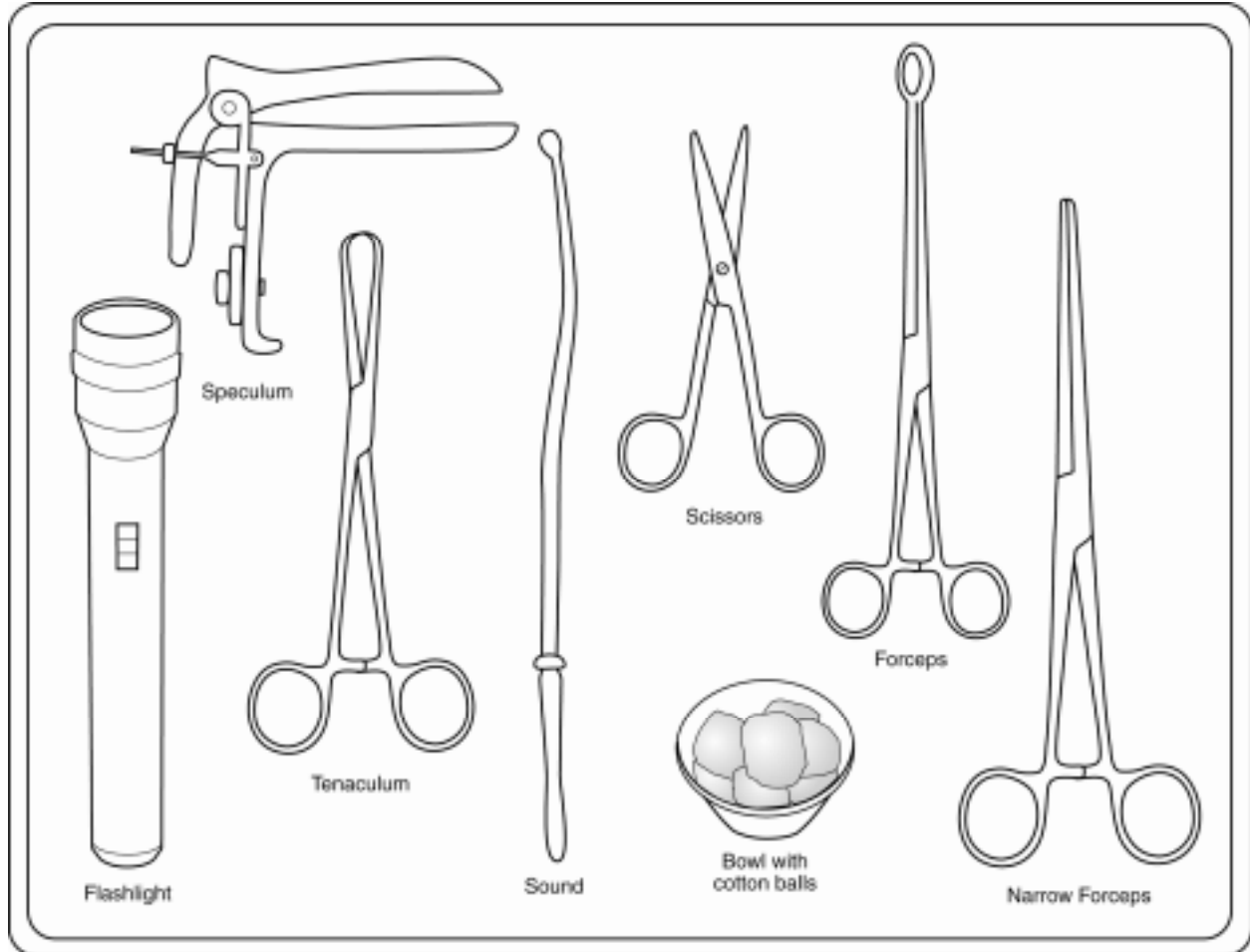
The following items are recommended for each IUD insertion (see also Figure 5-1):

- Drape to cover the woman's pelvic area
- Clean cloth to place between the woman and the examination table
- Gloves (new/clean or high-level disinfected surgical gloves or examination gloves)
- Bivalve speculum
- Light source sufficient to visualize cervix (e.g., flashlight)
- Uterine tenaculum
- Uterine sound
- IUD in an unopened, undamaged, sterile package that is not beyond its expiration date
- Sharp Mayo scissors
- Uterine dressing or sponge forceps
- Bowl containing:
  - Antiseptic solution for cleansing cervix (chlorhexidine or povidone iodine)
  - Gauze or cotton balls
- Dry gauze or cotton balls
- Narrow forceps (e.g., Bose, alligator) (for IUD removal)

---

**Important:** Have the supplies required for insertion readily available. If they are in a sterile or high-level disinfected package, do not open the package before the pelvic examination has been completed and a final decision to insert the IUD has been made.

---

Figure 5-1. Instruments and Other Key Items Needed for IUD Insertion<sup>1</sup>

### Basics of the Copper T 380A and TCu 380A with Safe Load

A working knowledge of the basic structure and main parts of the IUD and its packaging—as well as the associated terminology—is critical to the provision of quality IUD services. The insertion assemblies (parts used in insertion) and packaging of the Copper T 380A and the TCu 380A with Safe Load are presented and labeled in Figure 5-2. Key terminology is defined as follows:

- The clear **insertion tube** is used to guide the loaded IUD through the cervical os and into the uterus.
- The white **plunger rod** (or insertion or solid rod) is pushed to release the IUD from the insertion tube and into the uterus.
- The blue **depth-gauge** (or flange) is used to set the appropriate measurement (i.e., corresponding to the depth of the uterus) on the insertion tube, and to ensure that the arms of the T unfold in the proper direction (i.e., along a horizontal plane) once they are released from the insertion tube.

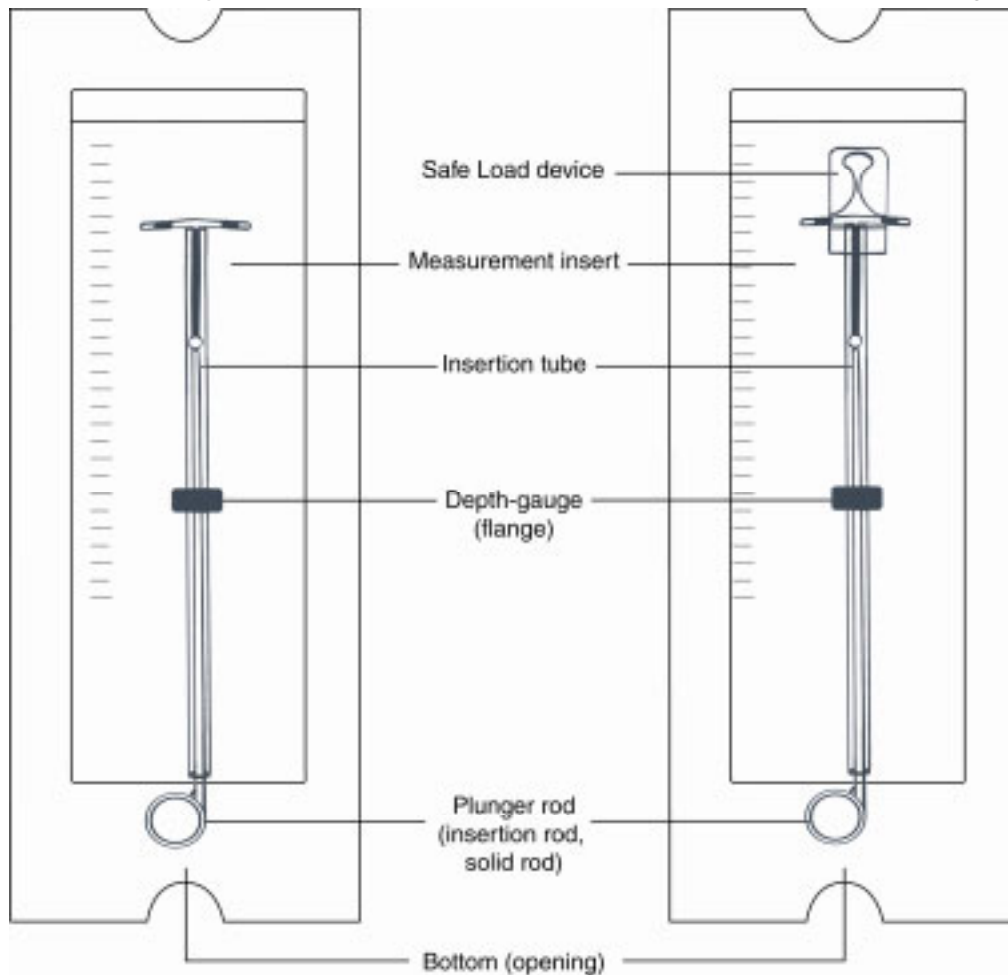
<sup>1</sup> Adapted from: Hatcher 1983.

## IUD Insertion and Removal

- The **measurement insert** is used to set the blue depth-gauge to the appropriate measurement on the insertion tube.

Do **not** open the IUD package or bend the arms of the “T” before the pelvic examination has been completed and a final decision to insert the IUD has been made.

Figure 5-2. “Anatomy” of the Copper T 380A (Left) and the TCu 380A with Safe Load (Right)



## IUD INSERTION

### Before Inserting the IUD<sup>2</sup>

**Important:** There are certain advantages to IUD insertions performed during or toward the end of menstruation—for example, there is little likelihood that the woman is pregnant, and bleeding and cramping may be less apt to cause anxiety. However, **an IUD can be inserted at any time during the menstrual cycle**, provided you can be reasonably sure the woman is not pregnant or at risk of being pregnant (as covered in Chapter 4).

<sup>2</sup> Many of these steps may have already been performed as part of the client assessment (if conducted during the same visit).

### ***Preinsertion Preparations***

If not already done:

- Ensure that an HLD pan (or sterile pack), supplies, and light source are available and ready for use.
- Using an HLD (or sterile) pick-up forcep, arrange the instruments and supplies in the HLD pan (or sterile pack), being very careful not to touch any parts that will go into the vagina or uterus.
- Ensure that the woman has recently emptied her bladder.
- Have her wash (with soap and water) and rinse her perineal area, if possible.
- Help her onto the examination table.
- Wash your hands thoroughly with soap and water; dry them with a clean, dry cloth or allow them to air dry.

### ***Preinsertion Assessment***

- Confirm that the woman has undergone appropriate assessment (as shown in Chapter 4) to ensure she is eligible for IUD insertion at this time.

### ***Preinsertion Education/Counseling***

- Provide an overview of the procedure, explaining what it involves and how long it will take.
- Explain that the procedure is very safe.
- Discuss the possibility of pain during the procedure. For example, you might say:
  - “You may feel some cramping and discomfort during and following IUD insertion—this is normal.”
  - “I will do my best to make the procedure as comfortable as possible, and alert you to possible pain before performing the step that might cause it.”
  - “Tell me if you feel any pain at any time.”

---

**Important:** If the woman has serious concerns about discomfort, offer her an NSAID, such as paracetamol or ibuprofen. Ideally, she would take it 30 minutes before the procedure.

---

- Ask her whether she has any questions or remaining concerns.
- Provide additional information and reassurance, as needed.

### **Sounding the Uterus<sup>3</sup>**

**Brief overview** of the procedure:

- Insert a speculum to visualize the cervix.
- Clean the cervix and vagina.
- Apply a tenaculum to the cervix.
- Gently pull the tenaculum to align the uterus, cervical opening, and vaginal canal.
- Insert the sound into the vagina and through the cervical opening.
- Advance the sound into the uterine cavity until a slight resistance is felt.
- Remove the sound and assess the level of mucus/blood to determine the depth of the uterus.

**Rationale:** This procedure is recommended for all IUD insertions to ensure high fundal placement of the IUD. Sounding the uterus also enables the provider to:

- Confirm the position of the uterus and check for obstructions in the cervical canal
- Identify the direction of the cervical canal and uterine cavity so that the insertion tube can be angled appropriately to follow the canal
- Assess the depth from external cervical os to the uterine fundus so that the blue depth-gauge on the insertion tube can be set at the same distance, thereby ensuring that the IUD will be placed as high in the uterine fundus as possible (without perforating the uterus)

Using gentle, “no-touch” (aseptic) technique throughout, perform the following steps:

**STEP 1: Prepare the client:**

- Give the woman a brief overview of the procedure (as shown above in grey box), encourage her to ask questions, and provide reassurance as needed.
- Remind her to let you know if she feels any pain.

**Figure 5-3. Inserting the Speculum**



**STEP 2: Put new/clean examination or high-level disinfected surgical gloves on both hands** (if not already done).

**STEP 3: Insert the high-level disinfected (or sterile) speculum and visualize the cervix** (if not already done) (Figure 5-3).<sup>4</sup>

If the cervix bleeds easily when touched, or purulent cervical discharge or other abnormal signs are found, **do not insert the IUD.**

<sup>3</sup> Adapted from: INTRAH 1993.

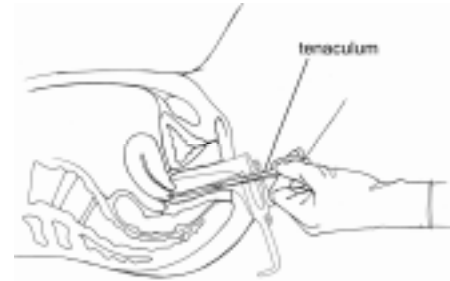
<sup>4</sup> This step generally overlaps with the speculum examination, as described in Chapter 4. For more information, see page 4-10.



**STEP 4: Cleanse the cervix and vagina with an appropriate antiseptic:** Thoroughly apply an appropriate antiseptic (e.g., povidone iodine or chlohexidine) two or more times to the cervix and vagina. If povidone iodine is used, ensure that the woman is not allergic to iodine and wait 2 minutes for the solution to act.

**STEP 5: Gently grasp the cervix with the high-level disinfected (or sterile) tenaculum and apply gentle traction:** Gently grasp the cervix with the tenaculum (Figure 5-4) and apply gentle traction (i.e., pull gently), which will help straighten the cervical canal for easier insertion of the IUD. **Close the tenaculum *only to the first notch to minimize discomfort.***

**Figure 5-4. Gently Grasping the Cervix with the Tenaculum**



**STEP 6: Carefully insert the high-level disinfected (or sterile) sound:** While maintaining gentle traction on the tenaculum, carefully insert the tip of the sound into the cervical os. **Be careful not to touch walls of vagina or the speculum blades with the tip of the sound.**

**STEP 7: Gently advance the sound into the uterine cavity, and STOP when a slight resistance is felt:**

- Advance the sound carefully and gently into the uterine cavity at the appropriate angle (based on your assessment of the position of the uterus during bimanual examination).
- Continue to pull steadily downward and outward on the tenaculum, which should enable the sound to pass through the os more easily.
  - If any resistance is felt at the level of the internal os, use a smaller sound, if available. Do **not** attempt to dilate cervix unless well qualified to perform this procedure.
  - If the woman begins to show signs of fainting, STOP advancing the sound into the uterine cavity.

Do **not** use force at any stage of this procedure.

- When you feel a **slight** resistance, STOP advancing the sound into the uterine cavity. (A slight resistance indicates that the tip of the sound has reached the fundus.)

## ***IUD Insertion and Removal***

- If a sudden loss of resistance is felt, the uterine depth is greater than expected, or the woman is experiencing unexplained pain, STOP advancing the sound into the uterine cavity. For guidance on managing possible uterine perforation, see page 6-15.

### **STEP 8: Note the angle of the uterine cavity (for IUD insertion), and gently remove the sound.**

Do **not** pass the sound into the uterus more than once.

### **STEP 9: Determine the depth of the uterus:**

- Determine the depth of the uterus by noting the level of mucus or wetness on the sound. (The average uterus is between 6 and 8 cm in depth. If the uterus is less than 6.5 cm in depth, the woman may be at increased risk for IUD expulsion.)
- Place the sound in 0.5% chlorine solution for 10 minutes for decontamination.

### **Loading the IUD in Its Sterile Package**

#### **Brief overview** of the procedure:

- Partially open the package.
- Place the plunger rod in the insertion tube.
- Place the “arms” of the “T” inside the insertion tube.
- Set the depth-gauge.
- Align the depth-gauge and folded arms of the T to horizontal position.
- Remove the IUD from the package.

**Rationale:** This simple but critical step prevents the IUD from being contaminated before it is inserted, further reducing the risk of postinsertion infection.

The Copper T 380A and TCu 380A with Safe Load differ significantly in how this step is performed. Both are loaded in their sterile packages, but the TCu 380A with Safe Load includes a special device that makes this easier to do.

- For guidance on loading the **regular Copper T 380A**, see Appendix C.
- For guidance on loading the **TCu 380A with Safe Load**, see Appendix D.

## Inserting the IUD<sup>5</sup>

**Brief overview** of the procedure:

- Gently pull the tenaculum to align the uterus, cervical opening, and vaginal canal.
- Insert the loaded IUD into the vagina and through the cervical opening.
- Advance the loaded IUD into the uterine cavity until the depth gauge comes in contact with the cervix or a **slight** resistance is felt.
- Withdraw the insertion tube to release the IUD into the uterus.
- Push gently on the plunger rod until a **slight** resistance is felt to ensure that the IUD is as high in the uterus as possible.
- Cut the IUD strings 3 to 4 cm from the cervical opening.

Using gentle, “no-touch” (aseptic) technique throughout, perform the following steps:

**STEP 1: Put new/clean examination or high-level disinfected surgical gloves on both hands** (if taken off to load the IUD).

**STEP 2: Prepare the client:**

- Give the woman a brief overview of the procedure (as shown above), encourage her to ask questions, and provide reassurance as needed.
- Remind her to let you know if she feels any pain.

**STEP 3: Gently grasp the tenaculum and apply gentle traction:** Hold the loaded IUD so that the blue depth-gauge is in the horizontal position with one hand, while grasping the tenaculum (still in place from sounding the uterus) with the other hand and gently pulling outward and downward. (This will help straighten the cervical canal for easier insertion of the IUD.)

**STEP 4: Carefully insert the loaded IUD:** Carefully insert the loaded IUD into the vaginal canal (Figure 5-5), and gently push it through the cervical os and into the uterine cavity at the appropriate angle (based on your assessment of the position of the uterus when sounding the uterus). **Be careful not to touch the walls of the vagina or the speculum blades with the tip of the loaded IUD.**

---

<sup>5</sup> Adapted from: PATH 1989.

## IUD Insertion and Removal

Figure 5-5. Inserting the Loaded IUD

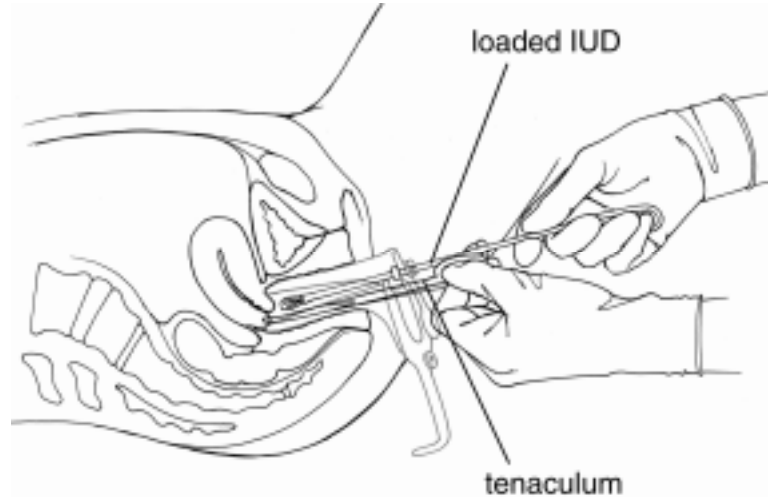
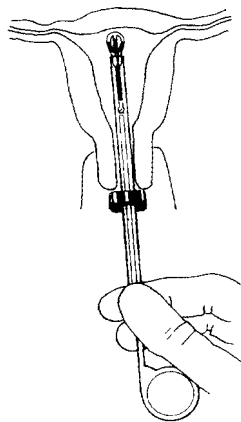


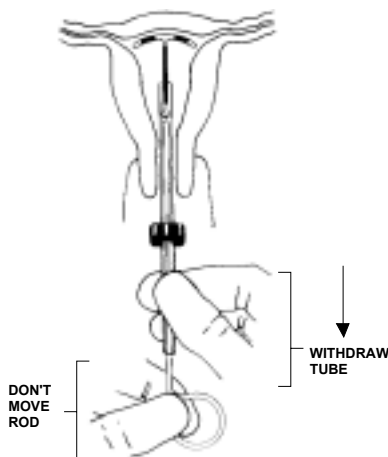
Figure 5-6. Advancing the Loaded IUD



**STEP 5:** Gently advance the loaded IUD into the uterine cavity, and **STOP** when the blue depth-gauge comes in contact with the cervix or **slight** resistance is felt (Figure 5-6). Be sure that the blue depth-gauge is still in the horizontal position.

Do **not** use force at any stage of this procedure.

Figure 5-7. Withdrawing the Insertion Tube to Release IUD Arms

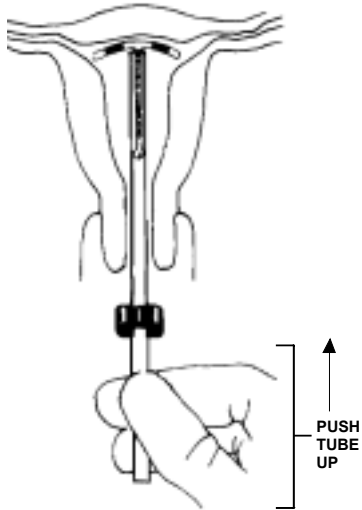


**STEP 6:** Hold the tenaculum and white plunger rod stationary, while partially withdrawing the insertion tube: While holding the tenaculum and plunger rod stationary (in one hand), gently pull the insertion tube toward yourself (with your free hand) until it **touches** the circular thumb grip of the white plunger rod (Figure 5-7). (This will release the IUD in the woman's uterus.)

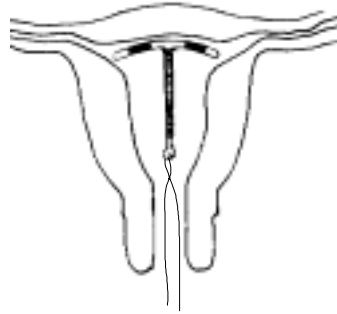
**STEP 7:** Remove the white plunger rod, while holding the insertion tube stationary.

**STEP 8:** Gently push insertion tube until you feel a **slight** resistance: Once the plunger rod has been removed, very gently and carefully push the insertion tube upward again, toward the fundus of the uterus, until you feel a **slight** resistance (Figure 5-8a). (This step ensures that the arms of the T are as high as possible in the uterus, as shown in Figure 5-8b.)

**Figure 5-8a. Positioning IUD High in the Uterus**



**Figure 5-8b. IUD Fully Inserted in Uterus**



Do **not** pass the loaded IUD into the uterus more than once.

**STEP 9: Use high-level disinfected (or sterile) sharp Mayo scissors to cut the IUD strings at 3 to 4 cm:**

- Partially withdraw the insertion tube from the cervical canal until the strings can be seen extending from the cervical os, and use sharp Mayo scissors to cut the strings at 3 to 4 cm from the cervical opening. (This technique ensures that the pieces of cut-off string will stay in the insertion tube for easy disposal.)
- Place the insertion tube and scissors in 0.5% chlorine solution for 10 minutes for decontamination.

**Note:** Sharp blades are very important. If the scissor blades are too dull to cut well, the IUD strings may become trapped in the closed blades of the scissors, and the IUD may be accidentally removed when the scissors are withdrawn.

**STEP 10: Gently remove the tenaculum and place it in 0.5% chlorine solution for 10 minutes for decontamination.**

**STEP 11: Examine the woman’s cervix for bleeding:** If there is bleeding where the tenaculum was attached to the cervix, use high-level disinfected (or sterile) forceps to place a cotton (or gauze) swab on the affected tissue, and apply gentle pressure for 30 to 60 seconds.

**STEP 12: Gently remove the speculum and place it in 0.5% chlorine solution for 10 minutes for decontamination.**

**STEP 13: Allow the woman to rest.** Advise the woman to remain on the examination table until she feels ready to get dressed. Begin performing the post-insertion steps (below) while she is resting.

## **After Inserting the IUD**

### ***Postinsertion Processing***

- Before removing your gloves:
  - Place all used instruments in 0.5% chlorine solution for 10 minutes for decontamination, if not already done.
  - Dispose of waste materials (e.g., cotton balls) by placing them in a leak-proof container (with tight-fitting lid) or plastic bag.
- Immerse both gloved hands in 0.5% chlorine solution. Remove gloves by turning them inside out.
  - If disposing of the gloves, place them in the leak-proof container or plastic bag.
  - If reusing the gloves (**not recommended**), submerge them in 0.5% chlorine solution for 10 minutes for decontamination.
- Wash your hands thoroughly with soap and water; dry them with a clean, dry cloth or allow them to air dry.
- After the client has left, wipe the examination table with 0.5% chlorine solution to decontaminate it.
- Ensure that all instruments, gloves, and other reusable items are further-processed according to recommended infection prevention practices (Table 3-1, page 3-13).

### ***Postinsertion Assessment***

- Ask the woman how she is feeling, and whether she is experiencing any of the following symptoms:
  - Nausea
  - Mild-to-moderate lower abdominal pain/cramping
  - Dizziness or fainting (rare)
- If the woman is experiencing any of these symptoms, provide reassurance and allow her to remain on the examination table to rest until she feels better.

---

**Important:** Although most women will **not** experience problems after IUD insertion, all women should remain at the clinic for 15 to 30 minutes before being discharged as a precaution.

---

### ***Postinsertion Education/Counseling***

- Before the woman leaves the clinic, counsel her on key messages for women who have just had an IUD inserted (Table 5-1).

For tips on helping the woman understand and remember the most important points, see Textbox 2-2 (page 2-4).

- As you progress through the messages, have her repeat back key information to ensure that she understands and has retained it. For example, you might ask:
  - “What are the common side effects, and what should you do if they occur?”
  - “What are the warning signs, and what should you do if they occur?”
  - “When should you return to the clinic?”
- When you finish, encourage her to ask questions and state any remaining concerns.
- Provide reassurance, as needed.

**Table 5-1. Key Messages for Women Who Have Just Had an IUD Inserted**

TOPIC	MESSAGES												
<b>Basic facts about your IUD</b>	<p><b>What you should know and do:</b></p> <ul style="list-style-type: none"> <li>● “You have a Copper T IUD.”</li> <li>● “It should be replaced in 12 years, but you can come back to have it removed for any reason whenever you wish.”</li> <li>● “It is effective immediately. You can have sexual intercourse as soon as you desire with no backup protection.”</li> </ul> <p>If possible, give the woman a reminder card, such as the one shown below:</p> <table border="1" style="width: 100%; border-collapse: collapse;"> <thead> <tr> <th colspan="2" style="text-align: center;">IUD-REMINDER CARD</th> </tr> </thead> <tbody> <tr> <td style="padding: 2px;">Client name:</td> <td style="border-bottom: 1px solid black; width: 80%;"></td> </tr> <tr> <td style="padding: 2px;">Type inserted:</td> <td style="border-bottom: 1px solid black; text-align: center;">[e.g., Copper T 380A]</td> </tr> <tr> <td style="padding: 2px;">Inserted on:</td> <td style="border-bottom: 1px solid black; text-align: center;">[Today’s date]</td> </tr> <tr> <td style="padding: 2px;">Remove/replace by:</td> <td style="border-bottom: 1px solid black; text-align: center;">[12 years from today’s date]</td> </tr> <tr> <td colspan="2" style="padding: 2px;">If you have problems or questions, go to [name and location of appropriate facility].</td> </tr> </tbody> </table>	IUD-REMINDER CARD		Client name:		Type inserted:	[e.g., Copper T 380A]	Inserted on:	[Today’s date]	Remove/replace by:	[12 years from today’s date]	If you have problems or questions, go to [name and location of appropriate facility].	
IUD-REMINDER CARD													
Client name:													
Type inserted:	[e.g., Copper T 380A]												
Inserted on:	[Today’s date]												
Remove/replace by:	[12 years from today’s date]												
If you have problems or questions, go to [name and location of appropriate facility].													
<b>No protection against STIs</b>	<p><b>What you should know:</b></p> <ul style="list-style-type: none"> <li>● “The IUD provides no protection against HIV or other STIs.”</li> </ul> <p><b>What you should do:</b></p> <ul style="list-style-type: none"> <li>● “If you think you or your partner could be at risk for exposure to HIV or other STIs, you should use a condom for protection every time you have sex.”</li> <li>● “Feel free to bring your partner to the clinic to further discuss this issue at any time.”</li> </ul>												

**IUD Insertion and Removal**

**Table 5-1. Key Messages for Women Who Have Just Had an IUD Inserted (continued)**

TOPIC	MESSAGES
<p><b>Possible side effects</b></p> <div style="border: 1px solid black; padding: 5px; margin-top: 10px;"> <p><b>Important:</b> Be clear about the possibility of menstrual changes with the IUD. If the woman knows what to expect, she is more likely to be satisfied with her choice and less likely to worry about side effects if they occur.</p> </div>	<p><b>What you should know:</b></p> <ul style="list-style-type: none"> <li>● “You may experience pain, light bleeding, and/or cramping immediately after IUD insertion. The cramping may last for a few days.”</li> <li>● “Many women experience heavier bleeding, longer bleeding, and more cramping than usual during their menstrual periods, and spotting between their periods. These symptoms usually lessen or go away within the first few months after IUD insertion.”</li> <li>● “Generally, these symptoms are not harmful and do not indicate a problem.”</li> </ul> <p><b>What you should do:</b></p> <ul style="list-style-type: none"> <li>● “You may take paracetamol or ibuprofen (not aspirin), as needed, to help lessen these symptoms.”</li> <li>● “Return to the clinic if these symptoms become bothersome.”</li> <li>● “If you experience bleeding that is twice as long or twice as heavy as usual, return to the clinic <b>immediately.</b>”</li> </ul>
<p><b>Warning signs (PAINS)</b></p> <div style="border: 1px solid black; padding: 5px; margin-top: 10px;"> <p><b>Note:</b> For more information about PAINS, see Textbox 5-1.</p> </div>	<p><b>What you should know:</b></p> <ul style="list-style-type: none"> <li>● “The following signs/symptoms (which spell the word PAINS) are warning signs for IUD users and may indicate a serious problem:  <b>P:</b> Period-related problems or pregnancy symptoms  <b>A:</b> Abdominal pain or pain during intercourse  <b>I:</b> Infections or unusual vaginal discharge  <b>N:</b> Not feeling well, fever, chills  <b>S:</b> String problems”</li> </ul> <p><b>What you should do:</b></p> <ul style="list-style-type: none"> <li>● “If you experience any of these warning signs (or PAINS), return to the clinic <b>immediately.</b>”</li> </ul>
<p><b>Checking for possible IUD expulsion</b></p> <div style="border: 1px solid black; padding: 5px; margin-top: 10px;"> <p><b>New Thinking about Checking IUD Strings:</b>  The importance of having the client check her IUD strings has been over-emphasized. IUD expulsion is uncommon, and undetected IUD expulsion is rare. Thus, unless the IUD was inserted immediately after childbirth or a second-trimester abortion (in which case the risk of IUD expulsion increases), the provider should minimize this aspect of counseling and focus more on the other messages.</p> </div>	<p><b>What you should know:</b></p> <ul style="list-style-type: none"> <li>● “IUD expulsion is most likely to occur within the first few months after IUD insertion (especially during menstruation).”</li> </ul> <p><b>What you should do:</b></p> <ul style="list-style-type: none"> <li>● “Check your strings occasionally during the first few months after IUD insertion (preferably after your menstrual period).”</li> <li>● “Check your menstrual cloth/pad/tampon and the latrine for an expelled IUD during your first few menstrual periods.”</li> <li>● “If you can not feel your IUD strings or suspect that your IUD has been expelled, begin using a back-up contraceptive method and return to the clinic immediately.”</li> </ul>



Table 5-1. Key Messages for Women Who Have Just Had an IUD Inserted (continued)

TOPIC	MESSAGES
When to return to the clinic	<p><b>What you should know and do:</b></p> <ul style="list-style-type: none"> <li>● “A single routine checkup is <b>recommended</b> after your first post-insertion menstrual period (3 to 6 weeks) but not later than 3 months after insertion.”</li> <li>● “You should return <b>immediately</b> if you experience warning signs (PAINS).”</li> <li>● “You should return if you want the IUD removed, there are changes in your reproductive goals or overall health, or you suspect STI exposure.”</li> <li>● “You should return in 12 years to have your IUD removed/replaced.”</li> <li>● “You should return if you have any problems or concerns, or for any reason at all.”</li> </ul>

**Textbox 5-1. PAINS: Warning Signs for IUD Users**

The woman should return the clinic immediately if she feels that she is seriously ill, or experiences any “PAINS”—PAINS stands for:

- P: Period-related problems or pregnancy symptoms.** If her period is late with signs of pregnancy; she has abnormal spotting after the first few days postinsertion, or spotting between periods or after intercourse; or she is bleeding twice as long or twice as heavily as usual, she should return to the clinic immediately.
- A: Abdominal pain or pain during intercourse.** If she has generalized lower abdominal pain with/without pain during intercourse (which may indicate pelvic infection), or crampy lower abdominal pain with/without pain (for her or her partner) during intercourse (which may indicate IUD expulsion), she should return to the clinic immediately.
- I: Infection or unusual vaginal discharge.** If she has any signs/symptoms of infection (e.g., purulent or foul-smelling vaginal discharge) or suspects she has been exposed to an STI, she should return to the clinic immediately. The risk of infection is greatest during the first 20 days postinsertion.
- N: Not feeling well, fever, and chills.** If she has any of these signs/symptoms (which are also indicative of infection), she should return to the clinic immediately. Again, the risk of infection is greatest during the first 20 days postinsertion.
- S: String problems.** If the IUD strings are missing, shorter, or longer, she should return to the clinic immediately. She should use a back-up method of contraception until she can come in for evaluation.

**IUD REMOVAL**

IUD removal is usually an uncomplicated and relatively painless routine procedure. Unless an IUD is removed for a medical reason or because the woman wishes to discontinue the method, a new IUD can be inserted **immediately** after removing the old one, if she so desires. Appropriate assessment and care, before and after the procedure, depend on the reason for IUD removal, and whether the woman is having another IUD inserted or is starting a different method. Note also that pre-procedure preparations and post-procedure processing steps are essentially the same as for IUD insertion, and are not repeated here.

**Note:** For routine IUD removals (especially if replacing the IUD), removal may be easier during the woman’s menstrual period, when the cervix softens. However, **IUDs can be removed at any time during the woman’s menstrual cycle.**

**Before Removing the IUD**

- Ask the woman her reasons for having the IUD removed:
  - If the woman wants her IUD removed for **personal reasons** (or offers **no reason at all**), remove her IUD. The woman has a

right to discontinue the method at any time, regardless of the reason.

- If the woman is having her **IUD replaced** (i.e., at the end of its effective life), ensure that she has undergone appropriate assessment to determine whether she is eligible for IUD reinsertion at this time.
- If she is having the IUD removed for **medical reasons** (e.g., pregnancy, dangerously heavy menstrual bleeding), ensure that she has undergone the appropriate assessment to determine whether routine IUD removal is safe for her at this time. Refer for special removals, if needed.
- If she will be **starting a different method**, ask when her LMP began. This will help determine whether she will need to use a back-up method (Textbox 5-3).
- Ensure that she understands the following key points about having her IUD removed, as appropriate:
  - “You can get pregnant again immediately after IUD removal.”
  - “If you do not want to become pregnant, you should **immediately** have another IUD inserted or start another contraceptive method.”
  - “No rest period is needed between IUDs.”
- Review her reproductive goals and need for protection against STIs.
- Help her choose a different contraceptive method, if appropriate.

### **Removing the IUD**

Using gentle, “no-touch” (aseptic) technique throughout, perform the following steps:

#### **STEP 1: Prepare the client:**

- Give the woman a brief overview of the procedure, encourage her to ask questions, and provide reassurance as needed.
- Remind her to let you know if she feels any pain.

#### **STEP 2: Put new/clean examination or high-level disinfected surgical gloves on both hands.**

#### **STEP 3: Insert a high-level disinfected (or sterile) speculum and visualize the cervix and the IUD strings.**

- If the strings can not be seen, manage as Missing Strings (page 6-11).

**STEP 4: Cleanse the cervix and vagina with an appropriate antiseptic:** Thoroughly apply an appropriate antiseptic (e.g., povidone iodine or chlohexidine) two or more times to the cervix (wiping from inside the os outward) and vagina. If povidone iodine is used, ensure that the woman is not allergic to iodine and wait 2 minutes for the solution to act.

**STEP 5: Alert the woman immediately before you remove the IUD:**

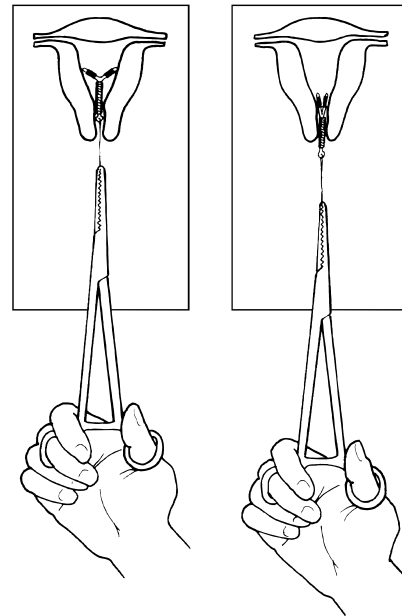
- Ask her to take slow, deep breaths and relax.
- Inform her that she may feel some discomfort and cramping, which is normal.

Do **not** use force at any stage of this procedure.

**STEP 6: Grasp the IUD strings and apply gentle traction:**

- Grasp the strings of the IUD with a high-level disinfected (or sterile) narrow forceps (Figure 5-9, Left panel).
- Apply steady but gentle traction, gently pulling the strings toward you with the forceps (Figure 5-9, Right panel). (The device can usually be removed without difficulty.)
  - If the strings break off but the IUD is visible, grasp the device with the forceps and remove it.
  - If removal is difficult, **do not use excessive force!** See Textbox 5-2 (below) for guidance on managing this problem.

**Figure 5-9. Removing the IUD**



**Textbox 5-2. Guidelines for Difficult IUD Removals**

**If you have partially removed the IUD but have difficulty drawing it through the cervical canal:**

- Attempt a gentle, slow twisting of the IUD while gently pulling.
- Continue as long as the woman remains comfortable.
  - If the IUD can still not be removed, refer the woman to a specially trained provider who can dilate the cervix.

**If there seems to be a sharp angle between the uterus and cervix:**

- Place a high-level disinfected (or sterile) tenaculum on the cervix, and apply gentle traction downward and outward.
- Attempt a gentle, slow twisting of the IUD while gently pulling.
- Continue as long as the woman remains comfortable.
  - If the IUD can still not be removed, refer the woman to a specially trained provider who can dilate the cervix.

## ***IUD Insertion and Removal***

**STEP 7: Show the woman the IUD, and place it in 0.5% chlorine solution for 10 minutes for decontamination.**

**STEP 8: Insert a new IUD, if the woman so desires and there are no precautions to continued use.** If she is not having a new IUD inserted, gently remove the speculum and place it in 0.5% chlorine solution for 10 minutes for decontamination.

### **After Removing the IUD**

- Ask the woman how she is feeling, and whether she is experiencing any of the following symptoms:
  - Nausea
  - Mild-to-moderate lower abdominal pain/cramping
  - Dizziness or fainting (rare)
- If the woman is experiencing any of these symptoms, provide reassurance and allow her to remain on the examination table to rest until she feels better.

---

**Important:** Although most women will **not** experience problems after IUD removal, all women should remain at the clinic for 15 to 30 minutes before being discharged as a precaution.

---

- If the woman is starting a new contraceptive method, it should be provided now—along with a back-up method if needed (Textbox 5-3).

#### **Textbox 5-3. Guidelines for Switching to Another Contraceptive Method and Need for Back-Up Methods<sup>6</sup>**

##### **If the woman is switching to combined oral contraceptives (COCs), and:**

- The IUD is being removed within 5 days since her LMP started, no back-up method is needed.
- The IUD is being removed at any other time, and:
  - She has been sexually active in this menstrual cycle, delay IUD removal until her next period.
  - She has not been sexually active in this menstrual cycle, provide a back-up method\* for her to use for the first 7 days after starting the COCs.

##### **If the woman is switching to any other method, and:**

- The IUD is being removed within 7 days since her LMP started, no back-up method is needed. The IUD can be removed at this time.
- If it is more than 7 days since her LMP started, and:
  - She has been sexually active in this menstrual cycle, delay IUD removal until her next period.
  - She has not been sexually active in this menstrual cycle, provide a back-up method\* for her to use for the first 7 days after starting the new method.

\* Back-up methods include abstinence, male and female condoms, spermicides, and withdrawal. Spermicides and withdrawal are the least effective methods. If possible, give the woman condoms. Note that the IUD can be left in place as the back-up method and removed during the next period.

<sup>6</sup> Source: WHO and JHU/CCP 2006.

## SIX

# FOLLOW-UP CARE AND MANAGEMENT OF POTENTIAL PROBLEMS

### BACKGROUND

The long-term success of a family planning/IUD program can be achieved only when service providers and other staff recognize the importance of providing strong support services to their clients. High-quality follow-up care for family planning clients contributes to greater user satisfaction, as well as to safe and effective continued use of the method.

After IUD insertion, a woman is advised to return to the clinic for her first routine checkup after her first postinsertion menses (3 to 6 weeks; not later than 3 months). She is also encouraged to return if she is experiencing problems, if there has been a change in her overall health, if she wants the IUD removed, or for any reason at all.

Routine follow-up for many IUD users may involve little more than answering questions and reinforcing key messages. Some users, such as those who are bothered by side effects, may require additional care and support. Serious problems related to IUD use are uncommon, but when they do occur, prompt and appropriate management is essential. This chapter highlights key components of support for the IUD user, focusing on the provision of routine follow-up care and the management of potential problems.

---

Although annual checkups for women with IUDs are not necessary, they are good general practice.

---

**Key objectives** of follow-up care for IUD clients are to:

- Assess the woman's overall satisfaction with the IUD
- Identify and manage potential problems
- Address any questions or concerns the woman may have
- Reinforce key messages

When providing follow-up care and managing potential problems, service providers and other health care staff should adhere to the **basic principles of quality IUD services**, as described in Chapter 1. Reminders of practices associated with these principles are integrated throughout the chapter.

## **FOLLOW-UP VISITS**

The basic components of routine follow-up care are essentially the same for new and continuing users. Some components, however, may be more important for new users, such as:

- Assessing for menstrual changes (most common side effect of IUD use), which often subside within a few months of IUD insertion;
- Assessing for infection, which is uncommon but most likely to occur in the first 20 days after IUD insertion; and
- Checking for IUD expulsion, which is very uncommon but most likely to occur within the first few months after IUD insertion.

For a continuing user, on the other hand, it may be more critical to assess for significant changes since her last visit, such as in her overall health, reproductive goals, or individual risk for HIV and other STIs.

Although the following guidelines are appropriate for all return visits, specific points that may be emphasized for new (\*) or continuing (\*\*\*) users are indicated as such.

### **Routine Follow-Up Assessment**

---

**Important:** If, at any point in the assessment, you find that the woman is **experiencing any problems** (e.g., PAINS) or other abnormal signs/symptoms:

- Refer to Management of Potential Problems (page 6-5), as appropriate; or
  - Conduct further evaluation and provide appropriate treatment according to national guidelines/local protocols (refer, if needed).
- 

### **History**

- Assess the woman's **overall satisfaction** with the method, and check for problems:
  - Ask the woman whether she has any questions or concerns.
  - Ask whether she is happy with the IUD, and ask whether she is having any problems.
    - If the woman seems unhappy with the IUD, follow the guidelines in Textbox 6-1.
- Assess for **common side effects\*** (e.g., an increase in the amount or duration of menstrual bleeding, increase in pain/cramping with period, or spotting/light bleeding between periods).
  - If the woman is experiencing side effects, follow the guidelines in Textbox 6-2.

---

\* May be more relevant for new IUD users

**Textbox 6-1. Follow-Up for Women Who Are Dissatisfied with the IUD**

**Important:** When a woman is unhappy with her IUD, finding out why enables you to:

- Determine whether her problems are easily resolvable (resulting in continuation of IUD use), if appropriate;
  - Identify problems that require further evaluation and/or treatment; and
  - Provide effective counseling about alternative contraceptive methods, if appropriate.
- Find out more about her reasons for being dissatisfied with the IUD.
  - Be sensitive to any worry or discomfort she may be feeling. **Do not dismiss her concerns!**
  - Provide reassurance and any information she needs to support her in continuing (or discontinuing) the method, as she desires.
  - If she wants the IUD removed, and/or to use a different contraceptive method, remove the IUD now (page 5-16) or schedule an appointment for IUD removal, as appropriate.

**Textbox 6-2. Follow-Up for Women Experiencing Menstrual Changes**

**Remember:** When women are given adequate reassurance, minor side effects are less likely to lead to discontinuation of the method.

- Find out more about her symptoms, and try to determine how well she is tolerating them.
  - If the woman seems very bothered by her symptoms; her symptoms are severe, have lasted more than 3 to 6 months after IUD insertion, or started long after IUD insertion; or you suspect a gynecologic problem, refer to Management of Potential Problems (page 6-5).
- Be sensitive to any worry or discomfort she may be feeling. **Do not dismiss her concerns!**
- Assure her that these symptoms are common in IUD users, do not usually indicate a problem, and will likely lessen or go away within the first few months.
- To help decrease the bleeding: Recommend ibuprofen (200–400 mg every 8 hours) during menstruation. **Aspirin should not be used.**
- To help decrease pain/cramping: Recommend ibuprofen (200–400 mg every 4–6 hours) or another NSAID immediately before and during menstruation.
- **Remind her that bleeding that lasts twice as long or is twice as heavy as usual is a warning sign, indicating the need to return to the clinic immediately for care.**

■ Screen for **warning signs (PAINS):**

- P: Period-related problems or pregnancy symptoms
- A: Abdominal pain or pain during intercourse
- I: Infections or unusual vaginal discharge
- N: Not feeling well, fever, chills
- S: String problems

(Additional information on PAINS is provided in Textbox 5-1, page 5-15.)

- Ask whether she has **checked for IUD expulsion**.\*
- Ask whether she has been using **condoms for protection against STIs**, as needed.

---

\* May be more relevant for new IUD users

## ***Follow-up Care and Management of Potential Problems***

- Screen for any **significant changes since the last visit:**\*\*
  - Changes in her overall health: Ask whether she has been ill, started a new medicine, been diagnosed with a condition, etc., since her last visit.
  - Changes in reproductive goals: Ask whether her plans to have children/more children have changed since her last visit.
  - Changes in individual risk for STIs: Ask her whether she or her partner has had any new sexual partners since her last visit.

### ***Physical Examination***

- For the **first routine checkup**, perform a pelvic examination to ensure that the IUD is still in place and check for signs of infection.
- For all **other return visits**, perform a pelvic examination as indicated (e.g., if infection is suspected).

### ***Routine Follow-Up Care and Support***

If the woman is **satisfied with the IUD** and is **not experiencing any problems**:

- Review warning signs (PAINS) that indicate a need to return to the clinic immediately.
- Encourage the use of condoms to protect against HIV and other STIs, as appropriate.
- Remind her to check for possible IUD expulsion during/after her first few menstrual periods.\*
- Remind her to return to the clinic if she wants her IUD removed, there are changes in her reproductive goals or overall health, she has any problems or concerns, or for any reason at all.
- Remind her of the date (month/year) when her IUD needs to be removed/replaced.

(Additional information on key messages for IUD users is provided in Textbox 5-1, page 5-13.)

---

\*\* May be more relevant for continuing IUD users

\* May be more relevant for new IUD users



## **MANAGEMENT OF POTENTIAL PROBLEMS<sup>1</sup>**

Most side effects associated with the use of IUDs are not serious and will resolve spontaneously. Some problems, however, require specific management. The purpose of the guidelines below is to assist the clinician in providing appropriate support for a woman experiencing such side effects or problems. **In most cases, the woman can continue to use the IUD while awaiting or undergoing evaluation.**

Some of the problems associated with IUD use that require specific management include:

- Changes in menstrual bleeding patterns (page 6-5)
- Cramping or pain (page 6-7)
- Infection (page 6-8)
- IUD string problems (or possible IUD expulsion) (page 6-10)
- Partial or complete expulsion IUD (confirmed) (page 6-12)
- Pregnancy with an IUD in place (page 6-13)
- Uterine perforation (page 6-15)

Some general principles that apply throughout are as follows:

- The woman should be provided reassurance and any information she needs to support her in continuing (or discontinuing) the method, as appropriate and as she desires.
- If problems are encountered that are not covered in the management guidelines, the provider should conduct further evaluation and provide treatment according to local protocols/national guidelines (refer if needed).
- If the provider does not have the training or resources to perform any of the assessments, procedures, or treatments indicated in the management guidelines, s/he should refer the woman to an appropriate facility.
- If the woman wants the IUD removed for any reason, and/or to use a different contraceptive method, remove the IUD now (page 5-15) or schedule an appointment for IUD removal, as appropriate.

### **Changes in Menstrual Bleeding Patterns**

Changes in menstrual bleeding patterns are a common side effect among users of copper-bearing IUDs. These changes are usually not harmful to the woman and diminish or disappear within the first few months after IUD insertion. If, however, these symptoms are severe, persistent, or accompanied by certain other signs/symptoms, they require special follow-up.

---

<sup>1</sup> *Adapted from:* Hatcher et al. 2004 and Hatcher et al. 2002–2003 (unless otherwise noted).

## ***Follow-up Care and Management of Potential Problems***

### **Possible Signs/Symptoms:**

- Increase in amount of menstrual bleeding
- Increase in duration of menstrual bleeding
- Spotting/light bleeding between periods

### **Steps to Address:**

STEP 1: Find out more about the woman's symptoms:

- How severe are they (how much more bleeding than usual)?
- How long have symptoms lasted (in relation to IUD insertion)?
- When did the symptoms start (in relation to IUD insertion)?
- Are they accompanied by other symptoms (e.g., pain, fever)?
- How well is the woman tolerating them?

---

**Important:** Bleeding that seems unrelated to menstruation (e.g., bleeding that occurs after sexual intercourse) could indicate a serious problem and requires prompt evaluation.

---

STEP 2: Manage as appropriate based on findings:

- If her menstrual bleeding lasts **twice as long or is twice as heavy** as usual, conduct further evaluation and provide treatment according to local protocols/national guidelines (refer if needed).
- If her menstrual bleeding changes have **continued beyond 3 to 6 months** after IUD insertion and a gynecologic problem is suspected, or **began long after IUD insertion**, conduct further evaluation and provide treatment according to local protocols/national guidelines (refer if needed).
- If her menstrual bleeding changes are **very bothersome to the woman** and she wishes to have the IUD removed, remove the IUD as soon as possible (see page 5-15).

**Note:** A woman with heavy or prolonged menstrual periods may be a good candidate for a hormone-releasing IUD such as Mirena, which has been shown to help reduce heavy menstrual bleeding.

- If her menstrual bleeding changes are **within normal range** (e.g., in the first 3 to 6 months after IUD insertion), provide reassurance and advice as shown in Textbox 6-2.
- If bleeding changes are **accompanied by anemia** (diagnosed or suspected), provide oral iron supplementation per national guidelines/local protocols; counsel on local, iron-rich foods.
- If bleeding changes are **accompanied by severe anemia** (diagnosed or suspected), counsel the woman on contraceptive methods that may be more appropriate.

### **Cramping or Pain (Menstrual)**

Increased cramping or pain associated with menstruation is another common side effect among users of copper-bearing IUDs. Special follow-up is needed, however, if these symptoms are bothersome, severe, or associated with other signs/symptoms that suggest they are not related to menstruation.

#### **Possible Signs/Symptoms:**

- Increased cramping or pain associated with menstruation

#### **Steps to Address:**

STEP 1: Find out more about the woman's symptoms:

- How severe are they?
- How long have symptoms lasted (in relation to IUD insertion)?
- When did the symptoms start (in relation to IUD insertion)?
- Are they accompanied by other symptoms (e.g., pain, fever)?
- How well is the woman tolerating them?

STEP 2: Conduct appropriate assessment (including pelvic examination) to identify or rule out other possible causes of the symptoms, such as infection, partial IUD expulsion, uterine perforation, and pregnancy/ectopic pregnancy.

## **Follow-up Care and Management of Potential Problems**

STEP 3: When other possible causes of the symptoms are ruled out, manage as appropriate based on findings:

- If cramping or pain is **severe**, remove the IUD (page 5-15).
  - If the IUD was improperly placed or looks abnormal, advise the woman that inserting a new IUD may solve the problem. If she does not want a new IUD, help her choose a more appropriate method.
  - If the IUD was properly placed or looks normal, help her choose a more appropriate method.
- If cramping or pain is **not severe**, provide reassurance and advice as follows:
  - Reassure the woman that this is a common side effect of the IUD, both in the first 1 or 2 days after IUD insertion and during her menstrual period in first few months after IUD insertion.
  - Explain that it is generally not harmful, and usually lessens in the first few months after IUD insertion.
  - Recommend ibuprofen (200–400 mg every 4–6 hours) or another NSAID immediately before and during menstruation to help reduce symptoms.

### **Infection<sup>2</sup>**

According to the latest research, the risk of infection after IUD insertion, while very low, is highest within the first 20 days after insertion. It is important to note that a pelvic infection does not necessarily develop into PID (PID refers to any infection that ascends into the woman's uterus and fallopian tubes), and that it is caused by gonorrhea or chlamydia, not the IUD. However, because PID can lead to infertility and other serious problems, and because diagnosis of PID can be difficult, providers should treat all suspected cases. The following guidelines are intended to assist the provider in identifying pelvic infection, including suspected cases of PID, and treating accordingly.

#### **Possible Signs/Symptoms:**

- Lower abdominal pain
- Painful intercourse
- Bleeding after sex or between periods
- Pain associated with periods (especially if this symptom was absent during the first few months after IUD insertion but developed later)

---

<sup>2</sup> Adapted from: WHO and JHU/CCP 2006.

- Abnormal vaginal discharge
- Painful urination (dysuria)
- Fever
- Nausea and vomiting

**Steps to Address:**

STEP 1: Conduct appropriate assessment (including abdominal and pelvic examinations) to identify or rule out other possible causes of the symptoms, such as ectopic pregnancy and appendicitis.

STEP 2: Suspect (presumptively diagnose) PID if any the following signs/symptoms are found and no other causes can be identified:

- Lower abdominal, uterine or adnexal tenderness (tenderness in the ovaries or fallopian tubes)
- Evidence or signs of cervical infection (yellowish cervical discharge containing mucus and pus, bleeding easily when the cervix is touched with a swab, or a positive swab test)
- Tenderness or pain when moving the cervix and uterus during pelvic exam (cervical motion tenderness)

Other possible signs/symptoms:

- Purulent cervical discharge
- Enlargement or hardening (induration) of one or both fallopian tubes
- A tender pelvic mass
- Pain when the abdomen is gently pressed (direct abdominal tenderness) or when gently pressed and then suddenly released (rebound abdominal tenderness)

STEP 3: Advise the woman that she should begin treatment immediately to avoid serious potential consequences of the infection, and that the IUD does not need to be removed during treatment (unless symptoms do not improve within 72 hours).

- If the woman does not want to keep the IUD in during treatment, arrange to have the IUD removed 2 to 3 days after antibiotic treatment has begun.

## ***Follow-up Care and Management of Potential Problems***

---

**Important:** Treatment should be started as soon as the presumptive diagnosis has been made, because prevention of long-term complications is more successful if appropriate antibiotics are given immediately. There is no need to remove the IUD for treatment of PID and STIs unless there is no improvement after 72 hours of treatment. Studies have not indicated that removing the IUD affects outcomes of treatment (ARHP 2004).

---

STEP 4: Treat the woman for gonorrhoea, chlamydia, and anaerobic infections according to national guidelines/local protocols.

STEP 5: Counsel the woman as follows:

- Urge condom use for protection against future STIs.
- Encourage her to have her partner(s) come in to receive treatment as soon as possible.
- Advise her to return to the clinic immediately if she develops lower abdominal pain or unusual vaginal discharge with fever.

STEP 6: Schedule a follow-up visit for 2 to 3 days after initiating antibiotic treatment.

- If the woman's symptoms of acute infection, such as pain, fever, and chills, have not improved, refer/transport her to a hospital.
- If the woman's symptoms have improved, schedule another follow-up visit for immediately after she has finished taking all of her medicine.

### **IUD String Problems (or Possible IUD Expulsion)**

Missing, shorter, or longer strings may indicate a variety of problems, including IUD expulsion or malposition and uterine perforation, or may not indicate a problem at all. Sometimes, for example, the IUD strings may ascend into the uterus for no known reason. Strings that are too short may bother the woman's partner during sexual intercourse. Guidance for following up on all these potential problems is provided below.

#### **Possible Signs/Symptoms:**

- Partner can feel strings
- Longer strings
- Shorter strings
- Missing strings

**Steps to Address:**

**For strings that can be felt by the woman's partner:**

- Reassure the woman (and her partner) that this probably means the strings were cut too short, and that it is not harmful.
- If it is very bothersome to the woman's partner, educate/counsel the woman as follows.
  - The IUD strings can be cut shorter (or curved around the cervical lip), but she may no longer be able to check them.
  - Alternately, a new IUD can be inserted and the strings cut long enough (at least 3 cm from the cervix) that her partner will not feel them, but that she will still be able to check them.

**For missing (or shorter or longer) strings:**

STEP 1: Rule out pregnancy.

STEP 2: Once pregnancy has been ruled out: Probe the cervical canal using a high-level disinfected (or sterile) cervical brush or narrow forceps (e.g., Bose, alligator) to locate the strings, and gently draw them out so that they are protruding into the vaginal canal. Manage as appropriate based on findings:

- If the strings are **located** and drawn out, and the woman wants to keep the IUD, leave it in place (provided it seems properly placed).
- If the strings are **located** and drawn out, and the woman does not want to keep the IUD, remove the IUD (page 5-16).
- If the strings are **not located** in the cervical canal (or cannot be drawn out), and the woman wants to keep the IUD, proceed to STEP 3. (Do not perform any intrauterine maneuvers, as these may dislodge the IUD.)
- If the strings are **not located** in the cervical canal (or cannot be drawn out), and the woman does not want to keep the IUD, refer her for IUD removal by a specially trained provider. (A specially trained provider can use a sound to check whether the IUD is in place, being very careful not to injure the uterus. If the IUD is still in place, the strings can be drawn out using a narrow forceps.)

STEP 3: If indicated (based on STEP 2), refer the woman for an X-ray (or ultrasound, if X-ray is unavailable) to help determine whether the IUD is still in place, is malpositioned,

## ***Follow-up Care and Management of Potential Problems***

or has been expelled. (**Important:** If the woman is not referred immediately for this procedure, provide a back-up method.) Manage as appropriate based on findings:

- If the IUD is **located** inside the uterus and the woman wants to keep the IUD, leave the IUD in place. Explain to her that the IUD is still protecting her from pregnancy, but she will no longer be able to feel the strings.
- If the IUD is **located** inside the uterus and the woman does not want to keep the IUD, refer her for IUD removal by a specially trained provider. (A specially trained provider can use narrow forceps to remove the IUD, but must be very careful not to injure the uterus.)
- If the IUD is **located** but is **outside of the uterus**, manage as Uterine Perforation (page 6-15).
- If the IUD is **not located** (i.e., completely expelled) or is **partially expelled**, manage as Partial or Complete IUD Expulsion (below).

### **Partial or Complete IUD Expulsion (Confirmed)**

Partial or complete IUD expulsion can occur unnoticed or may be associated with other signs/symptoms, such as irregular bleeding, pain with intercourse (for either woman or partner), unusual vaginal discharge, and/or bleeding after sex (ARHP 2004). Missing or longer IUD strings and delayed or missed menstrual period are other possible indications. The following guidelines address management of confirmed partial or complete IUD expulsions.

#### **Possible Signs/Symptoms:**

- Expelled IUD seen (complete expulsion)
- IUD felt/seen in the vaginal canal (partial expulsion)
- Delayed or missed menstrual period (see Pregnancy with an IUD in Place, page 6-13)
- Missing or longer strings (see IUD String Problems, page 6-10)

#### **Steps to Address:**

STEP 1: Conduct appropriate assessment (including pelvic examination) to rule out other possible causes of the symptoms, such as infection and pregnancy.



STEP 2: When other possible causes of the symptoms are ruled out, manage as appropriate based on findings:

- If complete expulsion of the IUD is confirmed (e.g., seen by the woman, confirmed by X-ray or ultrasound):
  - Replace IUD now if desired and appropriate (no signs of infection, pregnancy ruled out); or
  - Provide alternative method if possible, as well as a back-up method if needed.
- If partial IUD expulsion is confirmed (e.g., felt/seen by the woman or clinician partially expelled through the lateral fornices, or in the space between the outer surface of the cervix and the vaginal walls):
  - Remove the IUD (page 5-15)
  - Replace IUD now if desired and appropriate (no signs of infection, pregnancy ruled out); or
  - Provide alternative method if possible, as well as a back-up method if needed.
- If the IUD seems to be embedded in the cervical canal, refer/transport the woman for IUD removal by a specially trained provider.

### **Pregnancy with an IUD in Place<sup>3</sup>**

While the IUD is one of the most effective forms of reversible contraception, failures can occur. Approximately one-third of IUD-related pregnancies are due to undetected partial or complete expulsion of the IUD. When pregnancy does occur with an IUD in place, ectopic pregnancy must be ruled out and the IUD should be removed. If the IUD is left in place during pregnancy, there is an increased risk of preterm labor, spontaneous abortion, and septic abortion.

#### **Possible Signs/Symptoms:**

- Delayed or missed menstrual period
- Other signs/symptoms of pregnancy

#### **Steps to Address:**

STEP 1: Confirm pregnancy, if needed, and determine trimester. If the woman is in her second or third trimester of pregnancy, manage according to national guidelines/local protocols (refer, if needed).

---

<sup>3</sup> Adapted from: WHO and JHU/CCP 2006.

## ***Follow-up Care and Management of Potential Problems***

STEP 2: Rule out ectopic pregnancy.

- Severe or sudden sharp/stabbing pain, often unilateral, along with a combination of the following signs/symptoms is strongly suspicious for ectopic pregnancy.
  - Unusual abdominal pain or tenderness
  - Abnormal vaginal bleeding, no menstruation, change from usual menstrual patterns
  - Light-headedness/dizziness
  - Fainting

Do **not** perform a pelvic exam to confirm ectopic pregnancy unless surgical capabilities are readily available.

- If ectopic pregnancy is suspected, **immediately** refer/transport the woman to a facility that has surgical capabilities.

STEP 3: When ectopic pregnancy has been ruled out, determine whether the woman wants to continue her pregnancy.

- If the woman does not wish to continue her pregnancy:
  - Document her decision and obtain formal consent.
  - Remove the IUD immediately (page 5-15), even if her procedure is scheduled for later.
  - Provide support and care according to national guidelines/local protocols; refer if needed.
- If the woman wishes to continue her pregnancy, proceed to STEP 4.

STEP 4: If indicated (based on STEP 3), advise the woman that the IUD should be removed immediately (if in early pregnancy).

- Counsel the woman on the benefits and risks involved:
  - Removing the IUD slightly increases the risk of miscarriage
  - Leaving the IUD in place can cause second-trimester miscarriage, infection, and preterm delivery.
- Make clear that removing the IUD is the healthiest option for her and her baby.
- If the woman agrees to have the IUD removed, proceed to STEP 5.
- If the woman does not want to have the IUD removed, proceed to STEP 6.

STEP 5: Document the woman's decision and obtain formal consent and check for the IUD strings.

- If the strings are visible, remove the IUD (page 5-15) or refer for IUD removal.
- If the strings are not visible, do an ultrasound to determine whether the IUD is still in place or has been expelled. If the IUD is still in place, the IUD cannot be safely removed; proceed to STEP 6.

STEP 6: Provide support and care as follows, or according to national guidelines/local protocols (refer, if needed).

- Arrange to closely monitor the pregnancy.
- Stress the importance of returning to the clinic immediately if she experiences signs of spontaneous abortion or infection (e.g., fever, lower abdominal pain, and/or bleeding) or any other warning signs.
- Plan to remove the IUD at delivery.

### **Uterine Perforation<sup>4</sup>**

Uterine perforations occur very rarely, with most resulting from poor insertion technique. The clinical signs/symptoms of pain, vaginal bleeding, and rapid pulse in association with uterine perforation are also very rare. Instead, the first indication may be sudden loss of resistance to the sound or IUD insertion assembly, or uterine depth greater than expected (based on uterine sounding). Uterine perforation may also be discovered days, weeks, or months after the IUD insertion procedure. Such perforations are discovered and/or confirmed by X-ray or ultrasound.

Appropriate management of uterine perforation depends on when the perforation occurs and/or is discovered, whether it is partial (IUD embedded in the wall of the uterus) or complete (IUD outside the uterine cavity), and if there are associated signs/symptoms.

#### **Possible Signs/Symptoms:**

- Sudden loss of resistance to the uterine sound or IUD insertion device (during IUD insertion)
- Uterine depth greater than expected from uterine sound (during IUD insertion)
- Unexplained pain
- Confirmed partial or complete perforation (as shown by X-ray or ultrasound)

---

<sup>4</sup> Adapted from: WHO and JHU/CCP 2006.

## ***Follow-up Care and Management of Potential Problems***

### **Steps to Address:**

#### **Suspected uterine perforation during the IUD insertion procedure:**

STEP 1: Stop the procedure immediately, and gently remove the instrument/object that may have perforated the uterus (e.g., sound, IUD insertion assembly, IUD).

- If resistance is encountered, stop pulling and refer the woman **immediately** for laparoscopy for evaluation and/or removal by a qualified surgeon.
- If complete perforation is suspected, stabilize the woman and do an X-ray or ultrasound to see where the IUD is in the body; refer, if needed.
  - If the IUD is outside the uterus, refer the woman immediately for laparoscopy for IUD removal by a qualified surgeon.

---

**Important:** Only a qualified surgeon should attempt to remove an IUD by laparoscopy.

---

STEP 2: Have the woman rest and monitor her vital signs (blood pressure, pulse, respiration, and temperature) and level of discomfort until stable. For the first hour, check her vital signs every 5 to 10 minutes.

- If her vital signs are not stable (e.g., elevated pulse, falling blood pressure), or there is bleeding or new/increased pain, refer/transport the woman for emergency care.
- If her vital signs remain stable after 1 hour, check for signs of intra-abdominal bleeding (e.g., test hematocrit/hemoglobin). If there are signs of intra-abdominal bleeding, refer/transport the woman for emergency care.

STEP 3: When the woman's vital signs have been stable for several hours, she can go home. Advise her to avoid having sex for 2 weeks, provide a back-up method, and arrange for appropriate follow-up.

#### **Uterine perforation discovered within a few days or weeks of IUD insertion:**

STEP 1: If necessary, confirm the perforation/degree of perforation by X-ray or ultrasound.

STEP 2: Manage as appropriate based on findings:

- If the IUD is embedded in the wall of the uterus (partial perforation), refer the woman for IUD removal by a specially trained provider. (A specially trained provider can use narrow forceps to remove an IUD stuck in the wall of the uterus.)
- If the IUD is outside of the uterine cavity (complete perforation), refer the woman immediately for IUD removal by a surgeon qualified to perform laparoscopy or laparotomy.

**Uterine perforation discovered 6 weeks or more after IUD insertion:**

STEP 1: If necessary, confirm the perforation/degree of perforation by X-ray or ultrasound.

STEP 2: Manage as appropriate based on findings:

- If the IUD is embedded in the wall of the uterus (partial perforation), refer the woman for IUD removal by a specially trained provider. (A specially trained provider can use narrow forceps to remove an IUD stuck in the wall of the uterus.)
- If the IUD is outside of the uterine cavity (complete perforation):
  - Do not remove the IUD.
  - Advise the woman that it is safer to leave the IUD where it is than to remove it.

---

**Important:** After 6 weeks or more, copper-bearing IUDs that have completely perforated the uterus may become partially or completely covered with scar tissue and this rarely causes problems. Removal of the IUD, however, may lead to pelvic abscess (a mass-like collection of pus in the pelvic area) and other complications.

---

- Counsel the woman about reinserting a new IUD or starting a different contraceptive method.
- Insert new IUD now (if desired and appropriate) or provide another method (and back-up method, if needed).
- If the IUD is outside of the uterine cavity (complete perforation) **and** the woman has symptoms such as abdominal pain with associated diarrhea, or excessive bleeding, refer the woman immediately for IUD removal by a surgeon qualified to perform laparoscopy or laparotomy.

***Follow-up Care and Management of Potential Problems***

## APPENDIX A

# ADDITIONAL INFORMATION ON CHEMICALS USED IN INFECTION PREVENTION PROCESSES

This appendix is intended to supplement Chapter 3. It contains guidance on the following topics:

- Making dilute chlorine solutions for decontamination and HLD (pages A-1 to A-3)
- Choosing appropriate chemicals for HLD (pages A-3 and A-4)
- Storing chemicals and processing chemical containers (page A-4)
- Preparing and using chemical disinfectants (page A-5)

### MAKING DILUTE CHLORINE SOLUTIONS FOR DECONTAMINATION AND HLD

The WHO recommends 0.5% chlorine solution for decontaminating instruments before cleaning or when potable water is not available for making the solution (WHO 1989). For HLD, a 0.1% solution is satisfactory, provided boiled water is used for dilution.

Table A-1 describes how to make 0.5% and 0.1% chlorine solutions using commercially available liquid bleach products. The general formula for making a dilute solution from a commercial preparation of any concentration is shown in Textbox A-1.

The approximate amounts (in grams) needed to make 0.5% and 0.1% chlorine-releasing solutions from several commercially available compounds (dry powders) are listed in Table A-2. The formula for making a dilute solution from a powder of any percent available chlorine is listed in Textbox A-2.

**Additional Information on Chemicals Used in Infection Prevention Processes**

**Table A-1. Preparing Dilute Chlorine Solution from Liquid Bleach (Sodium Hypochlorite Solution) for Decontamination and HLD<sup>1</sup>**

TYPE OR BRAND OF BLEACH (BY COUNTRY)	CHLORINE % AVAILABLE	PARTS WATER TO 1 PART BLEACH <sup>a</sup>	
		0.5% <sup>c</sup>	0.1% <sup>b</sup>
8 °chlorum <sup>c</sup>	2.4%	4	23
JIK (Kenya), Robin Bleach (Nepal)	3.5%	6	34
12 °chlorum	3.6%	6	35
Household bleach (USA, Indonesia), ACE (Turkey), Eau de Javal (France) (15 °chlorum <sup>c</sup> )	5%	9	49
Blanquedor, Cloro (Mexico)	6%	11	59
Lavandina (Bolivia)	8%	15	79
Chloros (UK)	10%	19	99
Chloros (UK), Extrait de Javel (France) (48 °chlorum <sup>c</sup> )	15%	29	149

<sup>a</sup> Read as one part (e.g., cup or glass) concentrated bleach to x parts water (e.g., JIK [0.5% solution]—mix 1 cup bleach with 6 cups water for a total of 7 cups).

<sup>b</sup> Use boiled water when preparing a 0.1% chlorine solution for HLD because tap water contains microscopic organic matter that inactivates chlorine.

<sup>c</sup> In some countries, the concentration of sodium hypochlorite is expressed in chlorometric degrees (°chlorum); one °chlorum is approximately equivalent to 0.3% available chlorine.

**Textbox A-1. Formula for Making Dilute Chlorine Solution from Concentrated Solution**

Check concentration (% concentrate) of the chlorine product you are using. Determine total parts water needed using Table A-1 or the formula below.

$$\text{Total Parts (TP) Water} = \left[ \frac{\% \text{ Concentrate}}{\% \text{ Dilute}} \right] - 1$$

Mix 1 part concentrated bleach with the total parts water required.

**Example:** Make a dilute solution (0.5%) from 5% concentrated solution.

**STEP 1:** Calculate TP water:  $\left[ \frac{5.0\%}{0.5\%} \right] - 1 = 10 - 1 = 9$

**STEP 2:** Take 1 part concentrated solution and add to 9 parts water.

<sup>1</sup> Adapted from: WHO 1989.



**Table A-2. Preparing Dilute Chlorine Solution from Dry Powder<sup>2</sup>**

AVAILABLE CHLORINE REQUIRED	0.5%	0.1% <sup>a</sup>
Calcium hypochlorite (70% available chlorine)	7.1 g/L <sup>b</sup>	1.4 g/L
Calcium hypochlorite (35% available chlorine)	14.2 g/L	2.8 g/L
NaDCC <sup>c</sup> (60% available chlorine)	8.3 g/L	1.5 g/L
Chloramine tablets <sup>d</sup> (1 g of available chlorine per tablet)	20 g/L (20 tablets/liter) <sup>d</sup>	4 g/L (4 tablets/liter) <sup>d</sup>
NaDCC-based tablets (1.5 g of available chlorine per tablet)	4 tablets/liter	1 tablet/liter

<sup>a</sup> Use boiled water when preparing a 0.1% chlorine solution for HLD because tap water contains microscopic organic matter that inactivates chlorine.

<sup>b</sup> For dry powders, read x grams per liter (example: Calcium hypochlorite—7.1 grams mixed with 1 liter water).

<sup>c</sup> Sodium dichloroisocyanurate

<sup>d</sup> Chloramine releases chlorine at a slower rate than does hypochlorite. Before using the solution, be sure the tablet is completely dissolved.

**Textbox A-2. Formula for Making Dilute Chlorine Solution from Dry Powder**

Check concentration (% concentrate) of the powder you are using.  
Determine grams bleach needed using Table A-2 or the formula below.

$$\text{Grams/Liter} = \left[ \frac{\% \text{ Dilute}}{\% \text{ Concentrate}} \right] \times 1000$$

Mix measured amount of bleach powder with 1 liter of water.

**Example:** Make a dilute chlorine-releasing solution (0.5%) from a concentrated powder (35%).

**STEP 1:** Calculate grams/liter:  $\left[ \frac{0.5\%}{35\%} \right] \times 1000 = 14.2 \text{ g/L}$

**STEP 2:** Add 14.2 grams (14 g) to 1 liter of water.

### CHOOSING APPROPRIATE CHEMICALS FOR HLD

The two most commonly used chemicals approved for use as high-level disinfectants are chlorine (0.1%) and glutaraldehyde (2%). The major advantages and disadvantages of these chemicals are presented in Table A-3. Note that although alcohols and iodophors are disinfectants, they are no longer classified as high-level disinfectants. They should be used only when chlorine (0.1%) and glutaraldehyde (2%) are not available or appropriate.

<sup>2</sup> Adapted from: WHO 1989.

**Additional Information on Chemicals Used in Infection Prevention Processes**

**Table A-3. Advantages and Disadvantages of Commonly Used Chemicals Approved for Use in HLD**

DISINFECTANT	ADVANTAGES	DISADVANTAGES AND OTHER CONSIDERATIONS
Chlorine solutions (0.1%)	<ul style="list-style-type: none"> <li>• Fast-acting</li> <li>• Very effective against HBV and HIV</li> <li>• Inexpensive</li> <li>• Readily available</li> </ul>	<ul style="list-style-type: none"> <li>• Concentrated chlorine solutions (<math>\geq 0.5\%</math>) can discolor and corrode metals. <i>However</i>, stainless steel instruments can be soaked safely in a 0.1% chlorine solution (using a plastic container) for up to 20 minutes. Discoloration is a problem only when calcium (not sodium) hypochlorite powders are used. (Wiping instruments with vinegar, which is weakly acidic, will quickly remove the discoloration.) Also, corrosion will not be a problem if items are rinsed with boiled water and dried promptly.</li> <li>• Because chlorine solutions break down rapidly and can lose their effectiveness, fresh solutions should be made at least daily or more often if the solution is visibly cloudy.</li> </ul>
Glutaraldehyde (2%)	<ul style="list-style-type: none"> <li>• Can be used for HLD and sterilization</li> </ul>	<ul style="list-style-type: none"> <li>• Although less irritating than formaldehyde, glutaraldehyde should be used in well-ventilated areas following recommended precautions.</li> <li>• Because glutaraldehyde leaves a residue, instruments must be rinsed thoroughly with boiled water three times after HLD to remove any residue and prevent skin irritation.</li> </ul>

**STORING CHEMICALS AND PROCESSING CHEMICAL CONTAINERS**

- Disinfectants should be stored in a cool, dark area. Never store chemicals in direct sunlight or in excessive heat (e.g., upper shelves in a tin-roofed building).
- Glass containers used for toxic substances (e.g., glutaraldehyde, formaldehyde) may be washed with soap and water, rinsed, dried, and reused. Alternatively, they should be thoroughly rinsed with water (at least three times) and disposed of by burying.
- Plastic containers used for toxic substances should be thoroughly rinsed (at least two times) with water, punctured (so that they can not be used to carry water or other liquids), and disposed of by burning or burial.

**PREPARING AND USING CHEMICAL DISINFECTANTS**

Information on preparing and using high-level disinfectants and disinfectants is provided in Table A-4.

Table A-4. Preparing and Using Chemical Disinfectants<sup>3</sup>

CHEMICALS FOR STERILIZATION AND/OR HIGH-LEVEL DISINFECTION										
Disinfectant (common solution or brand)	Effective Concentration	How to Dilute	Skin Irritant	Eye Irritant	Respiratory Irritant	Corrosive	Leaves Residue	Time Needed for HLD	Time Needed for Sterilization	Activated Shelf Life <sup>a</sup>
Chlorine	0.1%	Dilution procedures vary <sup>b</sup>	Yes (with prolonged contact)	Yes	Yes	Yes <sup>c</sup>	Yes	20 minutes	Do not use	Change every 14 days, sooner if cloudy.
Glutaraldehyde (Cidex7)	Varies (2–4%)	Add activator	Yes	Yes (vapors)	Yes	No	Yes	20 minutes at 25°C <sup>d</sup>	10 hours for Cidex	Change every 14–28 days, sooner if cloudy.
CHEMICALS FOR DISINFECTION (Note: alcohols and iodophors are <b>not</b> high-level disinfectants.)										
Alcohol (ethyl or isopropyl)	60–90%	Use full strength	Yes (can dry skin)	Yes	No	No	No	Do not use	Do not use	If container (bottle) kept closed, use until empty.
Iodophors (10% povidone-iodine [PVI])	Approximately 2.5%	1 part 10% PVI to 3 parts water	No	Yes	No	Yes	Yes	Do not use	Do not use	If container (bottle) kept closed, use until empty.

<sup>a</sup> All chemical disinfectants are heat- and light-sensitive and should be stored away from direct sunlight and in a cool place (< 40°C).

<sup>b</sup> See Tables A-1 and A-2 for instructions on preparing chlorine solutions.

<sup>c</sup> Corrosive with prolonged (> 20 minutes) contact at concentrations > 0.5% if not rinsed immediately with boiled water.

<sup>d</sup> Different commercial preparations of Cidex and other glutaraldehydes are effective at lower temperatures (20°C) and for longer activated shelf life. **Always** check manufacturers' instructions.

<sup>3</sup> Adapted from: Rutala 1996.

***Additional Information on Chemicals Used in Infection Prevention Processes***

## APPENDIX B

# IUD CHECKLISTS<sup>1</sup>

### Checklist for Screening Clients Who Want to Initiate Use of the Copper IUD

Research findings over the past 20 years have established that intrauterine devices (IUDs) are safe and effective for use by most women, including those who have not given birth, who want to space births, and those living with or at risk of HIV infection. For some women, IUDs are not recommended because of the presence of certain medical conditions, such as genital cancer and current cervical infection. For these reasons, women who desire to use an IUD must be screened for certain medical conditions to determine if they are appropriate candidates for the IUD.



Family Health International (FHI), with support from the U.S. Agency for International Development (USAID), has developed a simple checklist (see center spread) to help health care providers screen clients who were counseled about contraceptive options and made an informed decision to use an IUD. The checklist is based on the guidance included in the *Medical Eligibility Criteria for Contraceptive Use* (WHO, 2004). It consists of a list of 20 questions designed to identify medical conditions and high-risk behaviors that would prevent safe IUD use or require further screening, as well as provide further guidance and directions based on clients' responses. A health care provider should complete the checklist before inserting an IUD. In some settings the responsibility for completing the checklist may be shared – with a counselor completing questions 1–13 and an appropriately trained health care provider, including a physician, midwife, clinical officer, nurse, or auxiliary nurse, determining the answers to the remaining questions during the pelvic exam. Clients who are ruled out because of their response to some of the medical eligibility questions may still be good candidates for an IUD after the suspected condition is excluded through appropriate evaluation.

This checklist is part of a series of provider checklists for reproductive health services. The other checklists include the *Checklist for Screening Clients Who Want to Initiate Combined Oral Contraceptives*, the *Checklist for Screening Clients Who Want to Initiate DMPA (or NET-EN)*, and the *Checklist on How to be Reasonably Sure a Client is Not Pregnant*. For more information about the provider checklists, please visit [www.fhi.org](http://www.fhi.org).

#### Determining Current Pregnancy

**Questions 1–6** are intended to help a provider determine, with reasonable certainty, whether a client is not pregnant. If a client answers “yes” to any of these questions and there are no signs or symptoms of pregnancy, it is highly likely that she is not pregnant. An IUD should never be inserted in a woman who is pregnant as it may result in a septic miscarriage. However, if a client answers “yes” to question 1, IUD insertion should be delayed until four weeks postpartum. There is an increased risk of perforating the uterus when IUDs are inserted after 48 hours and up to four weeks postpartum. However, IUDs can be inserted by a trained professional within the first 48 hours after the client has given birth.

#### Assessing Medical Eligibility for the IUD

**7. Do you have bleeding between menstrual periods that is unusual for you, or bleeding after intercourse (sex)?**

Unexplained vaginal bleeding may be a sign of an underlying pathological condition, such as genital malignancy (cancer), or a pregnancy-related problem. All these possibilities must be ruled out before an IUD can be inserted. If necessary, refer the client to a higher-level provider or specialist for evaluation and diagnosis. Counsel the client about other contraceptive options available and provide condoms to use in the meantime.

**8. Have you been told that you have any type of cancer in your genital organs, trophoblastic disease, or pelvic tuberculosis?**

There is a concern about the increased risk of infection, perforation, and bleeding at insertion in clients with genital cancer. Clients with trophoblastic disease may require multiple uterine curettages, and an IUD is unwise in this situation. There is also an increased risk of perforation. Clients with known pelvic tuberculosis may have a higher risk of secondary infection and bleeding if an IUD is inserted. If a woman has any one of these three conditions, she should not have an IUD inserted. Counsel her about other contraceptive options available and provide condoms to use in the meantime.

*Note: Questions 9–12 are intended to identify clients at high individual risk of sexually transmitted infections (STIs), because there is a possibility that they may currently have chlamydia and/or gonorrhea infection. Unless these STIs can be reliably ruled out, clients at high risk are not good candidates for IUD insertion. IUD insertion may increase risk of pelvic inflammatory disease (PID) in these clients. They should be counseled about other contraceptive options and provided with condoms for STI protection. However, if other contraceptive methods are not available or acceptable and there are no signs of STI, an IUD still can be inserted. Careful follow-up is required in such cases.*

<sup>1</sup> Copyright Family Health International, 2006. This tool is reprinted with permission from Family Health International. For more information, visit FHI's Web site at <http://www.fhi.org>.

## Checklist for Screening Clients Who Want to Initiate Use of the Copper IUD

First, be reasonably sure that the client is not pregnant. If she is not menstruating at the time of her visit, ask the client questions 1–6. As soon as the client answers **YES** to *any* question, stop, and follow instructions below.

<b>YES</b>	1. Have you had a baby in the last 4 weeks?	<b>NO</b>
<b>YES</b>	2. Did you have a baby less than 6 months ago, are you fully or nearly-fully breastfeeding, and have you had no menstrual period since then?	<b>NO</b>
<b>YES</b>	3. Have you abstained from sexual intercourse since your last menstrual period or delivery?	<b>NO</b>
<b>YES</b>	4. Did your last menstrual period start within the past 12 days?	<b>NO</b>
<b>YES</b>	5. Have you had a miscarriage or abortion in the last 7 days?	<b>NO</b>
<b>YES</b>	6. Have you been using a reliable contraceptive method consistently and correctly?	<b>NO</b>

If the client answered **YES** to *any one* of questions 1–6 and she is free of signs or symptoms of pregnancy, you can be reasonably sure that she is not pregnant. Proceed to questions 7–13. However, if she answers **YES** to question 1, the insertion should be delayed until 4 weeks after delivery. Ask her to come back at that time.

If the client answered **NO** to *all* of questions 1–6, pregnancy cannot be ruled out. The client should await menses or use a pregnancy test.

To determine if the client is medically eligible to use an IUD, ask questions 7–13. As soon as the client answers **YES** to *any* question, stop, and follow instructions below.

<b>NO</b>	7. Do you have bleeding between menstrual periods that is unusual for you, or bleeding after intercourse (sex)?	<b>YES</b>
<b>NO</b>	8. Have you been told that you have any type of cancer in your genital organs, trophoblastic disease, or pelvic tuberculosis?	<b>YES</b>
<b>NO</b>	9. Within the last 3 months, have you had more than one sexual partner?	<b>YES</b>
<b>NO</b>	10. Within the last 3 months, do you think your partner has had another sexual partner?	<b>YES</b>
<b>NO</b>	11. Within the last 3 months, have you been told you have an STI?	<b>YES</b>
<b>NO</b>	12. Within the last 3 months, has your partner been told that he has an STI or do you know if he has had any symptoms – for example, penile discharge?	<b>YES</b>
<b>NO</b>	13. Are you HIV-positive and have you developed AIDS?	<b>YES</b>

If the client answered **NO** to *all* of questions 7–13, proceed with the **PELVIC EXAM**.

During the pelvic exam, the provider should determine the answers to questions 14–20.

If the client answered **YES** to question 7 or 8, an IUD cannot be inserted. Further evaluation of the condition is required.  
 If the client answered **YES** to *any* of questions 9–12, she is not a good candidate for an IUD unless chlamydia and/or gonorrhea infection can be reliably ruled out.  
 If she answered **YES** to the *second part* of question 13 and is not currently taking ARV drugs, IUD insertion is not usually recommended. If she is doing clinically well on ARV's, the IUD may generally be inserted. HIV-positive women without AIDS also generally can initiate IUD use.

<b>NO</b>	14. Is there any type of ulcer on the vulva, vagina, or cervix?	<b>YES</b>
<b>NO</b>	15. Does the client feel pain in her lower abdomen when you move the cervix?	<b>YES</b>
<b>NO</b>	16. Is there adnexa tenderness?	<b>YES</b>
<b>NO</b>	17. Is there purulent cervical discharge?	<b>YES</b>
<b>NO</b>	18. Does the cervix bleed easily when touched?	<b>YES</b>
<b>NO</b>	19. Is there an anatomical abnormality of the uterine cavity that will not allow appropriate IUD insertion?	<b>YES</b>
<b>NO</b>	20. Were you unable to determine the size and/or position of the uterus?	<b>YES</b>

If the answer to *all* of questions 14–20 is **NO**, you may insert the IUD.

If the answer to *any* of questions 14–20 is **YES**, the IUD cannot be inserted without further evaluation. See explanations for more instructions.





**9. Within the last 3 months, have you had more than one sexual partner?**

Clients who have multiple sexual partners are at high risk of contracting STIs. Unless chlamydia and/or gonorrhea infection can be reliably ruled out, these clients are not good candidates for IUD insertion. (See note regarding questions 9–12.)

**10. Within the last 3 months, do you think your partner has had another sexual partner?**

Clients whose partners have more than one sexual partner are at high risk of contracting STIs. Unless chlamydia and/or gonorrhea infection can be reliably ruled out, these clients are not good candidates for IUD insertion. In situations where polygamy is common, the provider should ask about sexual partners outside of the union. (See note regarding questions 9–12.)

**11. Within the last 3 months, have you been told you have an STI?**

There is a possibility that these clients currently have chlamydia and/or gonorrhea infection. Unless these STIs can be reliably ruled out, these clients are not good candidates for IUD insertion. (See note regarding questions 9–12.)

**12. Within the last 3 months, has your partner been told that he has an STI or do you know if he has had any symptoms – for example, penile discharge?**

(Note: There are two parts to this question. Answering “yes” to either part or both parts of the question restricts IUD insertion.)

Clients whose partners have STIs may have these infections as well. Unless chlamydia and/or gonorrhea infection can be reliably ruled out, these clients are not good candidates for IUD insertion. (See note regarding questions 9–12.)

**13. Are you HIV-positive and have you developed AIDS?**

This is a two part question, and both parts must be asked together. If the woman answers “yes” to both parts, ask whether she is taking ARVs and make sure she is doing clinically well. If she is, she may be a candidate for the IUD. If she is not, an IUD is usually not recommended unless other more appropriate methods are not available or not acceptable. There is concern that HIV-positive clients who have developed AIDS and are not taking ARVs may be at increased risk of STIs and PID because of a suppressed immune system. IUD use may further increase that risk. If the woman is HIV-positive but has not developed AIDS, the IUD may generally be used.

**Pelvic Examination****14. Is there any type of ulcer on the vulva, vagina, or cervix?**

Genital ulcers or lesions may indicate a current STI. While an ulcerative STI is not a contraindication for IUD insertion, it indicates that the woman is at high individual risk of STIs, in which case IUDs are not generally recommended. Diagnosis should be established and treatment provided as needed. An IUD can still be inserted if co-infection with gonorrhea and chlamydia are reliably ruled out.

**15. Does the client feel pain in her lower abdomen when you move the cervix?**

Cervical motion tenderness is a sign of PID. Clients with current PID should not use an IUD. Treatment should be provided as appropriate. If necessary, referral should be made to a higher-level provider or specialist. Counsel the client about condom use and other contraceptives.

**16. Is there adnexa tenderness?**

Adnexa tenderness or/and adnexa mass is a sign of a malignancy or PID. Clients with genital cancer or PID should not use an IUD. Diagnosis and treatment should be provided as appropriate. If necessary, referral should be made to a higher-level provider or specialist.

**17. Is there purulent cervical discharge?**

Purulent cervical discharge is a sign of cervicitis and possibly PID. Clients with current cervicitis or PID should not use an IUD. Treatment should be provided as appropriate. If necessary, referral should be made to a higher-level provider or specialist. Counsel the client about condom use.

**18. Does the cervix bleed easily when touched?**

If the cervix bleeds easily at contact, it may indicate that the client has cervicitis or cervical cancer. Clients with current cervicitis or cervical cancer should not have an IUD inserted. Treatment should be provided as appropriate. If necessary, referral should be made to a higher-level provider or specialist. If, through appropriate additional evaluation beyond the checklist, these conditions may be excluded, then the woman can receive the IUD.

**19. Is there an anatomical abnormality of the uterine cavity that will not allow appropriate IUD insertion?**

If there is an anatomical abnormality that distorts the uterine cavity, proper IUD placement may not be possible. Cervical stenosis also may preclude an IUD insertion.

**20. Were you unable to determine the size and/or position of the uterus?**

Determining size and position of the uterus is essential before IUD insertion to ensure high fundal placement of the IUD and to minimize the risk of perforation.

***IUD Checklists***



## APPENDIX C

# INSTRUCTIONS FOR LOADING THE *REGULAR* COPPER T 380A IN ITS STERILE PACKAGE<sup>1</sup>

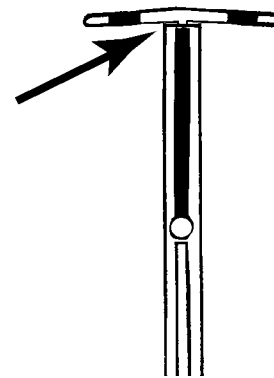
Do **not** open the IUD's sterile package or load it (as instructed below) until the final decision to insert an IUD has been made (i.e., until after the pelvic examination, including both bimanual and speculum exams, has been performed). In addition, do not bend the "arms" of the "T" into the insertion tube more than 5 minutes before the IUD is to be introduced into the uterus.

While performing the following steps, do not allow any part of the IUD or the IUD insertion assembly to touch any non-sterile surfaces (e.g., your hands, the table) that may contaminate it:

### STEP 1: Adjust the contents of the package through the clear plastic cover:

- Ensure that the vertical stem of the T is fully inside the insertion tube (Figure C-1, arrow).
- Ensure that the other end of the insertion tube (farthest from the IUD) is close to the sealed end of the package.

Figure C-1. Vertical Stem of T Fully inside Insertion Tube



### STEP 2: Partially open the package:

- Place the package on a clean, hard, flat surface with the clear plastic side up.
- Pull up on the clear plastic cover from the end that is farthest from the IUD (marked OPEN).
- Keep pulling the plastic cover until the package is open approximately half way to the blue depth-gauge.

### STEP 3: Place the white plunger rod in the clear insertion tube:

- Pick up the package, holding the open end up toward the ceiling so that the contents do not fall out.
- Starting at the open end of the package, fold the clear plastic cover and white backing "flaps" away from each other (as shown in Figure C-2a).
- Using your free hand, grasp the white plunger rod (behind the measurement insert) by the circular thumb grip and remove it from the package.

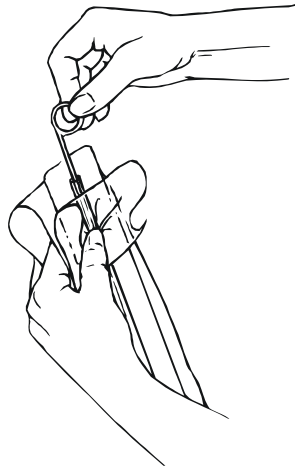
<sup>1</sup> Adapted from: Pregna International Ltd. 2006; PATH 1989.

**Instructions for Loading the Regular Copper T 380A in Its Sterile Package**

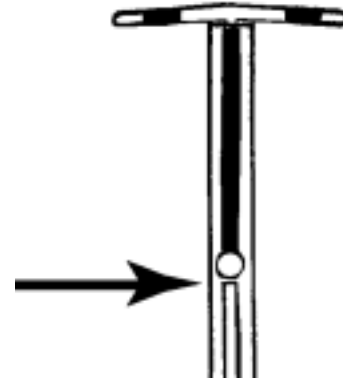
Do **not** touch the tip of the white plunger rod or brush it against another surface, as this will cause it to lose its sterility.

- Place the plunger rod inside the insertion tube (Figure C-2a) and gently push until the tip of the rod almost touches the bottom of the T (Figure C-2b, arrow).

**Figure C-2a. Placing White Plunger Rod inside Insertion Tube**



**Figure C-2b. Plunger Rod almost Touching Bottom of T**

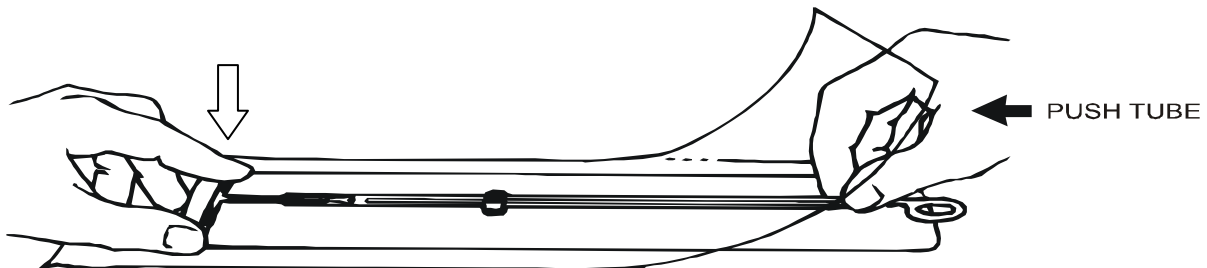


**STEP 4: Bend the “arms” of the “T” downward:**

Do **not** bend the arms of the T into the insertion tube more than 5 minutes before it is introduced into the uterus.

- Release the white backing flap so that it is flat again, and place the package back on the clean, hard, flat surface with the clear plastic side up.
- Through the clear plastic cover, place your thumb and index finger over the tips of the horizontal arms of the T to stabilize the IUD (Figure C-3, open arrow).

**Figure C-3. Positioning IUD and Bending Arms of T**



### **Instructions for Loading the Regular Copper T 380A in Its Sterile Package**

- At the open end of the package, use your free hand to push the measurement insert so that it slides underneath the IUD and stops at the sealed end of the package.
- Still holding the tips of the arms of the T, use your free hand to grasp the insertion tube and gently push it against the T (Figure C-3, solid arrow). This pressure will cause the arms to begin bending downward, toward the stem of the T (as shown on the measurement insert).
- Finish bending the arms of the T by bringing your thumb and index finger together, and continuing to push against the T with the insertion tube.

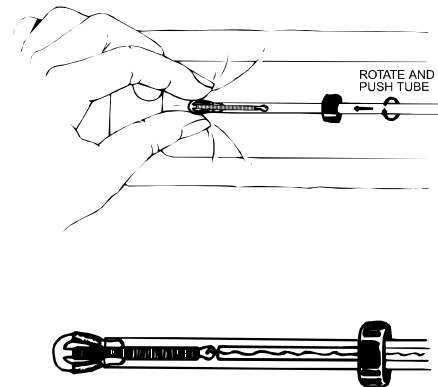
#### **STEP 5: Pull the insertion tube away from the folded arms of the T:**

When the arms of the T are folded down enough to touch the sides of the insertion tube, pull the insertion tube out from between the arms.

#### **STEP 6: Push the folded arms of the T into the insertion tube:**

- Gently push and rotate the insertion tube back over the **tips** of the folded arms of the T, so that both tips are caught inside the insertion tube (Figure C-4, Upper image). (As you maneuver the tips of the arms into the opening of the tube, it may help to slightly elevate the other end of the tube.)
- Push the folded arms of the IUD into the insertion tube only as far as necessary to keep them fixed in the tube (Figure C-4, Lower image). Do not try to push the copper bands on the arms into the insertion tube, as they will not fit.

**Figure C-4. Inserting Folded IUD Arms into Insertion Tube**



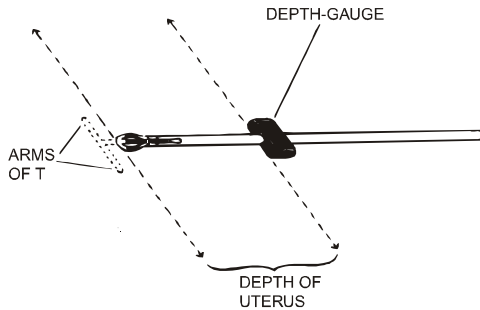
#### **STEP 7: Set the blue depth-gauge to the appropriate measurement:**

With the loaded IUD still in the partially unopened package, set the blue depth-gauge to the corresponding measurement obtained from sounding the uterus:

- Move the depth-gauge so that its inside edge (the edge closest to the IUD) is aligned with the appropriate centimeter mark on the measurement insert (e.g., 6 cm, 7.5 cm, 8 cm).
- Press down on the depth-gauge with the thumb and index finger of one hand to keep it in place, while sliding the insertion tube with your other hand until the tip of the IUD (the top of the folded T) aligns with

## Instructions for Loading the Regular Copper T 380A in Its Sterile Package

**Figure C-5. Using Blue Depth-Gauge to Set Depth of Uterus on Insertion Tube**



the tip in the diagram on the measurement insert. This is the “0” centimeter mark.

- Ensure that the distance between tip of the IUD and the inside edge of the depth-gauge is equal to the depth of the uterus as determined by uterine sounding (Figure C-5).

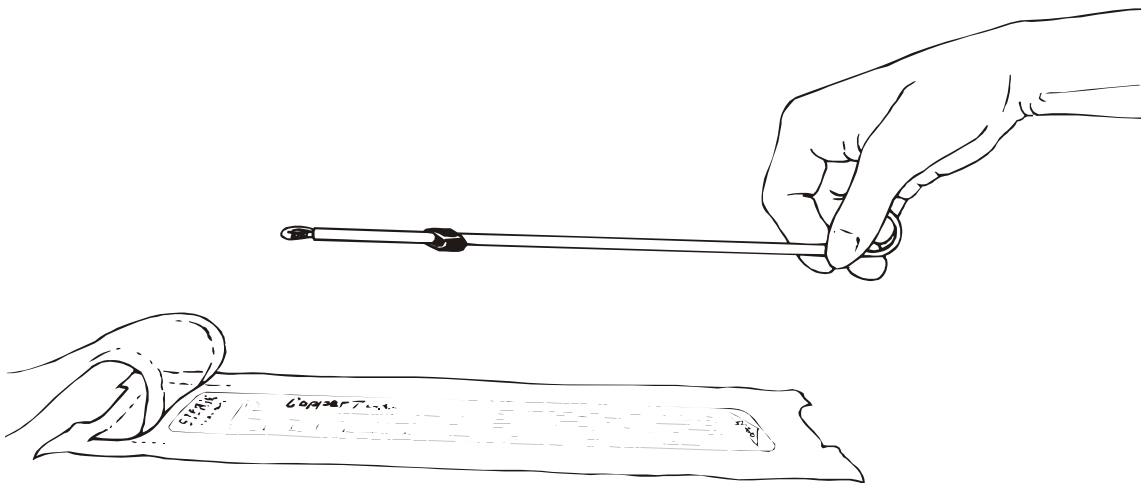
**STEP 8: Align the depth-gauge and the folded arms of the T so that they are both in a “horizontal” position (i.e., flat against the measurement insert).**

**STEP 9: Remove the loaded IUD from the package:**

- Finish peeling back the clear plastic cover from the white backing in one brisk, continuous movement with one hand, while holding the insertion assembly down against the white backing on the table (at the open end of the package) with the other hand.
- Lift the loaded IUD from the packaging, keeping it level so that the T and white plunger rod do not fall out (Figure C-6). **Be careful not to push the white rod toward the T, as this will release the IUD from the insertion tube.**

Do **not** let the IUD or IUD insertion assembly touch any non-sterile surfaces that may contaminate it.

**Figure C-6. IUD Fully Loaded in Insertion Tube**



You are now ready to insert the IUD, as instructed in Chapter 5 (page 5-9).

## APPENDIX D

# INSTRUCTIONS FOR LOADING THE TCU 380A WITH SAFE LOAD IN ITS STERILE PACKAGE<sup>1</sup>

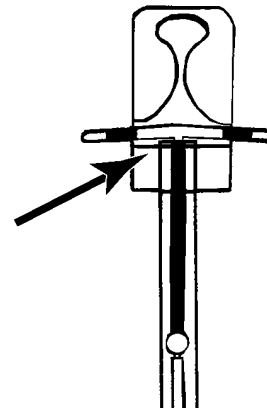
Do **not** open the IUD's sterile package or load it (as instructed below) until the final decision to insert an IUD has been made (i.e., until after the pelvic examination, including both bimanual and speculum exams, has been performed). In addition, do not bend the "arms" of the "T" into the insertion tube more than 5 minutes before it is introduced into the uterus.

While performing the following steps, do not allow the IUD or the IUD insertion assembly to touch any non-sterile surfaces (e.g., your hands, the table) that may contaminate it:

**STEP 1: Adjust the contents of the package through the clear plastic cover:**

- Ensure that the vertical stem of the T is fully inside the insertion tube (Figure D-1, arrow).
- Ensure that the other end of the insertion tube (farthest from the IUD) is close to the sealed end of the package.

Figure D-1. Vertical Stem of T Fully inside Insertion Tube



**STEP 2: Partially open the package:**

- Place the package on a clean, hard, flat surface with the clear plastic side up.
- Pull up on the clear plastic cover from the end that is farthest from the IUD (marked OPEN).
- Keep pulling the plastic cover until the package is open approximately half way to the blue depth-gauge.

**STEP 3: Place the white plunger rod in the clear insertion tube:**

- Pick up the package, holding the open end up toward the ceiling so that the contents do not fall out.
- Starting at the open end of the package, fold the clear plastic cover and white backing "flaps" away from each other.
- Using your free hand, grasp the white plunger rod (behind the measurement insert) by the circular thumb grip and remove it from the package (as shown in Figure D-2a).

<sup>1</sup> Adapted from: Pregna International Ltd. 2006; PATH 1989.

## Instructions for Loading the TCu 380A with Safe Load in Its Sterile Package

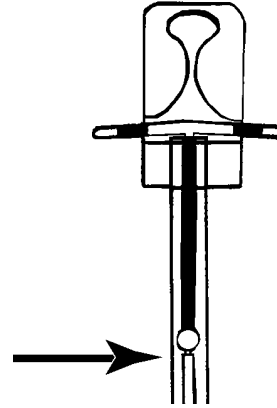
Do **not** touch the tip of the white plunger rod or brush it against another surface, as this will cause it to lose its sterility.

- Place the plunger rod inside the insertion tube (Figure D-2a) and gently push until the tip of the rod almost touches the bottom of the T (Figure D-2b, arrow).

Figure D-2a. Placing White Plunger Rod inside Insertion Tube



Figure D-2b. Plunger Rod almost Touching Bottom of T



### STEP 4: Push the insertion tube into the Safe Load device:

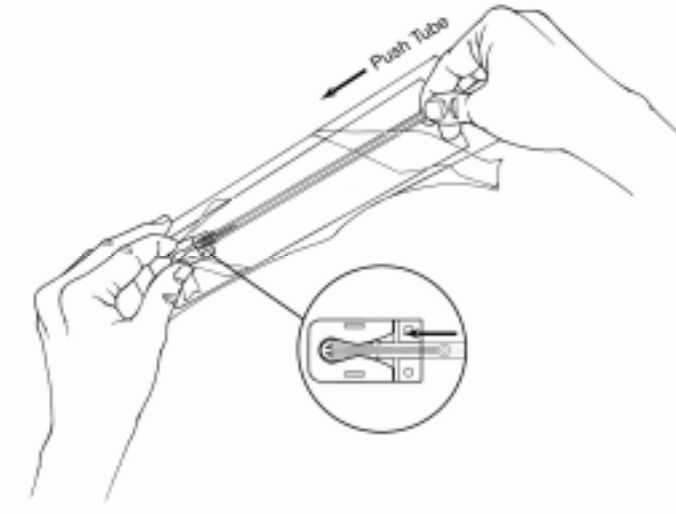
- Release the white backing flap so that it is flat again, and place the package back on the clean, hard, flat surface once again with the clear plastic side up.
- Through the clear plastic cover, place your thumb and index finger on either side of the Safe Load device to stabilize it (Figure D-3a).
- At the open end of the package, use your free hand to push the measurement insert so that it slides underneath the IUD and stops at the sealed end of the package.
- Still holding the Safe Load device, use your free hand to grasp the insertion tube and gently push it against the Safe Load device (Figure D-3b). This pressure will cause the “arms” of the “T” to begin bending downward, toward the stem of the T.
- Continue pushing until the arms of the T are inside the “profile” of the Safe Load device (Figure D-3b, insert).

**Instructions for Loading the TCu 380A with Safe Load in Its Sterile Package**

**Figure D-3a. Stabilizing Safe Load Device**

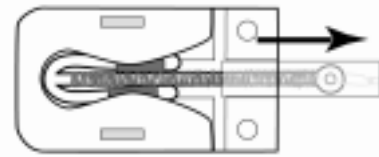


**Figure D-3b. Pushing Arms of T into Safe Load Device**



**STEP 5: Remove the insertion tube from the Safe Load device:** When the arms of the T are touching the sides of the insertion tube, slowly pull the insertion tube away from the folded arms of the IUD until it comes out of the Safe Load device (Figure D-4).

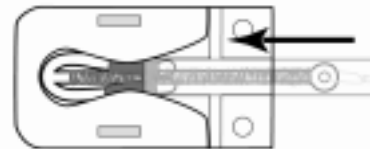
**Figure D-4. Pulling Insertion Tube out of Safe Load Device**



**STEP 6: Push the folded arms of the T into the insertion tube.**

- While keeping the Safe Load device flat on the table, gently push and rotate the insertion tube back over the **tips** of the folded arms of the T, so that both tips are caught inside the insertion tube (Figure D-5).
- Push the folded arms of the IUD into the insertion tube only as far as necessary to keep them fixed in the tube. **Do not try to push the copper bands on the arms into the insertion tube, as they will not fit.**

**Figure D-5. Introducing Arms of T into Insertion Tube**



**STEP 7: Remove the loaded IUD from the Safe Load device.**

- Turn the insertion tube by 90 degrees (in either direction), as shown in Figure D-6a.
- Gently withdraw the insertion tube along with the loaded IUD from the device, but do not remove the loaded IUD from the package (Figure D-6b).

**Instructions for Loading the TCU 380A with Safe Load in Its Sterile Package**

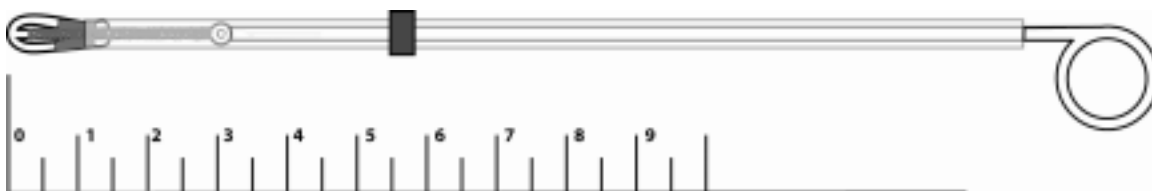
**Figure D-6a and b. Removing IUD from Safe Load Device**



**STEP 8: Set the blue depth-gauge to the appropriate measurement:** With the loaded IUD still in the partially unopened package, set the blue depth-gauge to the corresponding measurement obtained from sounding the uterus:

- Move the depth-gauge so that its inside edge (the edge closest to the IUD) is aligned with the appropriate centimeter mark on the measurement insert (e.g., 6 cm, 7.5 cm, 8 cm).
- Press down on the depth-gauge with the thumb and index finger of one hand to keep it in place, while sliding the insertion tube with your other hand until the tip of the IUD (the top of the folded T) is aligned with the “0” centimeter mark on the measurement insert.
- Ensure that the distance between the tip of the IUD and the inside edge of the depth-gauge is equal to the depth of the uterus as determined by uterine sounding (Figure D-7).

**Figure D-7. Using Blue Depth-Gauge to Set Depth of Uterus on Insertion Tube**



**STEP 9: Align the depth-gauge and the folded arms of the T so that they are both in a “horizontal” position (i.e., flat against the measurement insert).**

**STEP 10: Remove the loaded IUD from the package:**

- Finish peeling back the clear plastic cover from the white backing in one brisk, continuous movement with one hand, while holding the insertion assembly down against the white backing on the table (at the open end of the package) with the other hand.



***Instructions for Loading the TCU 380A with Safe Load in Its Sterile Package***

- Lift the loaded IUD from the packaging, keeping it level so that the T and white plunger rod do not fall out. **Be careful not to push the white rod toward the T, as this will release the IUD from the insertion tube.**

Do **not** let the IUD or IUD insertion assembly touch any non-sterile surfaces that may contaminate it.

You are now ready to insert the IUD, as instructed in Chapter 5 (page 5-9).

***Instructions for Loading the TCU 380A with Safe Load in Its Sterile Package***

# BIBLIOGRAPHY

Alvarez F, Brache V, Fernandez E, et al. 1988. New insights on the mode of action of intrauterine contraceptive devices in women. *Fertil Steril* 49: 768–773.

American Association of Operating Room Nurses (AORN). 1990. Clinical Issues. *AORN J* 52(3): 613–615.

Andersson K, Batar I and Rybo G. 1992. Return to fertility after removal of a levonorgestrel-releasing intrauterine device and Nova-T. *Contraception* 46: 575–584.

Association of Reproductive Health Professionals (ARHP). 2004. New developments in intrauterine contraception. In: *Clinical Proceedings of the ARHP*, Washington, DC, September. ARHP: Washington, DC.

Backman T, Huhtala S, Luoto R, et al. 2002. Advance information improves user satisfaction with the levonorgestrel intrauterine system. *Obstet Gynecol* 99: 608–613.

Belhadj H et al. 1986. Recovery of fertility after use of the levonorgestrel 20 mcg/d or Copper T 380 Ag intrauterine device. *Contraception*. 1986 Sep; 34(3): 261–267.

Bonilla R et al. 2005. Factors for expulsion of intrauterine device Tcu380A applied immediately postpartum and after a delayed period. *Rev Med Inst Mex Seguro Soc*. 43(1):5–10.

Buchan H, Villard-Mackintosh L, Vessey M, et al. 1990. Epidemiology of pelvic inflammatory disease in parous women with special reference to intrauterine device use. *Br J Obstet Gynaecol* 97: 780–788.

Centers for Disease Control and Prevention (CDC). 2002. Sexually transmitted diseases treatment guidelines. *Morbidity and Mortality Weekly Report*, May 10, vol 51, no RR-6. CDC: Atlanta, Georgia.

Chi I. 1993. What we have learned from recent IUD studies: A researcher's perspective. *Contraception* 48 81–108.

Dannemiller Memorial Educational Foundation. 1998. Patient update: What to expect when having an intrauterine device inserted. *Contracept Rep* 9(4).

Darney PD. 2001. Time to pardon the IUD? *N Engl J Med* 345: 608–610.

Espey E and Ogbourn T. 2002. Perpetuating negative attitudes about the intrauterine device: Textbooks lag behind the evidence. *Contraception* 65(6): 389–395.

## Bibliography

- Family Health International (FHI). 2006. Checklist for screening clients who want to initiate use of the copper IUD (electronic version). In: The Maximizing Access and Quality Initiative—IUD Toolkit. ([http://www.maqweb.org/iudtoolkit/service\\_delivery/iudchecklist.shtml](http://www.maqweb.org/iudtoolkit/service_delivery/iudchecklist.shtml))
- Farley TM, Rosenberg MJ, Rowe PJ, et al. 1992. Intrauterine devices and pelvic inflammatory disease: An international perspective. *Lancet* 339: 785–788.
- FHI. 1997. Risk assessments to improve screening. *Networks*. Winter 17(2). [http://www.fhi.org/en/RH/Pubs/Network/v17\\_2/nt1722.htm](http://www.fhi.org/en/RH/Pubs/Network/v17_2/nt1722.htm)
- FHI. 1988. These strings don't need tuning. In: *IUDs—A New Look*, Population Reports Series B(5): 1–31. FHI: Durham, NC.
- Forrest JD. 1996. US Women's perceptions of and attitudes about the IUD. *Obstet Gynecol Surv* 51: S30–S34.
- Gallen M, Lettenmaier C, and Green CP. 1987. Counseling makes a difference. *Population Reports Series J*(35): 1B31.
- Ganacharya S, Bhattoa HP, and Batar I. 2003. Ectopic pregnancy among non-medicated and copper-containing intrauterine device users: A 10-year follow-up. *Eur J Obstet Gynecol Reprod Biol* 111(1): 78–82.
- Garner JS and The Hospital Infection Control Practices Advisory Committee (HICPAC). 1996. Guideline for isolation precautions in hospitals. *Infect Control Hosp Epidemiol* 17(1): 53–80 and *Am J Infect Control* 24(1): 24–52.
- Grimes DA. 2004. Intrauterine devices (IUDs). In: Hatcher RA, Trussell J, Stewart F, et al. (Eds) *Contraceptive Technology*. Ardent Media, Inc.: New York.
- Grimes DA. 2000. Intrauterine device and upper genital tract infection. *Lancet* 356: 1013–1019.
- Grimes DA, Schulz KF, and Stanwood N. 2002. Immediate post-abortion insertion of intrauterine devices. *Cochrane Database Syst Rev* 3: CD001777.
- Grimes D, Schulz K, van Vliet H, and Stanwood N. 2003. Immediate postpartum insertion of intrauterine devices. *Cochrane Database Sys Rev* 1: CD003036
- Harrison-Woolrych M, Ashton J, and Coulter D. 2003. Uterine perforation on intrauterine device insertion: Is the incidence higher than previously reported? *Contraception* 67: 53–56.
- Hatcher R et al. 2002–2003. *A Pocket Guide to Managing Contraception*. Ardent Media, Inc.: New York.
- Hatcher R, Trussell J, Stewart F, et al. 2004. *Contraceptive Technology*, 18th ed. Ardent Media, Inc.: New York.

- Hubacher D and Grimes DA. 2002. Noncontraceptive health benefits of intrauterine devices: A systematic review. *Obstet Gynecol Surv* 57: 120-128.
- Hubacher D, Lara-Ricalde R, Taylor DJ, et al. 2001. Use of copper intrauterine devices and the risk of tubal infertility among nulligravid women. *N Engl J Med* 3445: 561–567.
- Huezo C and C Briggs. 1992. Medical and Service Delivery Guidelines. International Planned Parenthood Federation Medical Department: London.
- I-cheng Chi. 1992. The Multiload IUD—A US researcher’s evaluation of a European device. *Contraception*. 46: 407–425.
- Ladipo OA et al. 1991. Prevention of IUD-related pelvic infection: The efficacy of prophylactic doxycycline at IUD insertion. *Adv Contracept* 7(1): 43–54.
- Lara R et al. 2006 (in press). A randomized comparative study between the intrauterine devices Multi-load Cu375 and TCU 380A, inserted immediately post partum. *Gineco Obst Mex*.
- Lettenmaier C and ME Gallen. 1987. Why counseling counts! *Population Reports Series J*(36): 1B28.
- Muller AL et al. 2005. Transvaginal ultrasonographic assessment of the expulsion rate of intrauterine devices inserted in the immediate postpartum period: A pilot study. *Contraception* 72(3):192–195.
- Nelson AL. 2000. The intrauterine contraceptive device. *Obstet Gynecol Clin North Am* 27(4): 723–740.
- Penney G, Brechin S, de Souza A, et al. 2004. FFPRHC Guidance (January 2004). The copper intrauterine device as long-term contraception. *J Fam Plann Reprod Health Care* 30: 29–41; quiz 42.
- Perkins JJ. 1983. The central service department. In: *Principles and Methods of Sterilization in Health Sciences*, 2nd ed. Charles C. Thomas: Springfield, Illinois.
- Peterson HB et al. 1996. The risk of pregnancy after tubal sterilization: Findings from the US collaborative review of sterilization [and discussion]. *Am J Obstet Gynecol* 174: 1161–1170.
- Porter CW. 1987. Prevention of infection in voluntary surgical contraception. *Biomedical Bulletin* 6(1): 1–7.
- Pregna International, Ltd. 2006. Pregna Copper T 380A and Pregna Safe Load. (<http://www.pregna.com>)
- Program for International Training in Health (INTRAH). 1993. *Guidelines for Clinical Procedures in Family Planning: A Reference for Trainers*. INTRAH: Chapel Hill, North Carolina.
- Richardson BA et al. 1999. Effect of intrauterine device use on cervical shedding of HIV-1 DNA. *AIDS* 13: 2091–2097.

## Bibliography

- Rivera et al. 2006. Essential knowledge about the IUD (electronic version). In: The Maximizing Access and Quality Initiative—IUD Toolkit. ([http://www.maqweb.org/iudtoolkit/knowledge\\_base/index.shtml](http://www.maqweb.org/iudtoolkit/knowledge_base/index.shtml))
- Rivera R, Yacobson I and Grimes D. 1999. The mechanism of action of hormonal contraceptives and intrauterine contraceptive devices. *Am J Obstet Gynecol* 181: 1263–1269.
- Rutala WA. 1993. Disinfection, sterilization and waste disposal. In: *Prevention and Control of Nosocomial Infections*, 2nd ed. Wenzel RP (Ed). Williams & Wilkins: Baltimore.
- Salem R. 2006. New attention to the IUD: Expanding women's contraceptive options to meet their needs. *Populations Reports, Series B*, February (7). Johns Hopkins Bloomberg School of Public Health, The INFO Project: Baltimore.
- Salle AJ. 1973. *Fundamental Principles of Bacteriology*, 7th ed. McGraw-Hill Book Company: New York.
- Segal SJ, Alvarez-Sanchez F, Adejuwon CA, et al. 1985. Absence of chorionic gonadotropin in sera of women who use intrauterine devices. *Fertil Steril* 44: 214–218.
- Sevki C et al. 2004. Clinical outcomes of early postplacental insertion of intrauterine contraceptive devices. *Contraception* 69(4):279–282.
- Shelton J and R Rivera. 2004. IUDs: A resurging method. In: *Global Health Technical Briefs* (Info Project at the Johns Hopkins University [JHU]/Center for Communications Programs [CCP]). JHU/CCP: Baltimore, MD.
- Shelton J. 2001. The provider perspective: Human after all. *Int Fam Plann Perspect* 27: 152–153, 161.
- Sinei SK et al. 2001. Complications of use of intrauterine device appropriate contraception for HIV-positive women? *BJOG* 108: 748–790.
- Sinei SK, Morrison CS, Sekadde-Kigonda C, et al. 1998. Complications of use of intrauterine devices among HIV-1-infected women. *Lancet* 351: 1238–1241.
- Sinei SK, Schulz KF, Lamptey PR, et al. 1990. Preventing IUCD-related pelvic infection: the efficacy of prophylactic doxycycline at insertion. *Br J Obstet Gynaecol* 97: 412–419.
- Sivin I et al. 1991. Prolonged intrauterine contraception: A seven-year randomized study of the levonorgestrel 20 mcg/day and the Copper T380A IUDs. *Contraception* 44: 473–480.
- Skjeldestad F and Bratt H. 1998. Fertility after complicated and non-complicated use of IUDs: A controlled prospective study. *Adv Contracept* 4: 179–184.

Spaulding EH et al. 1968. Chemical disinfection of medical and surgical materials. In: *Disinfection, Sterilization and Preservation*, 1st ed. Lawrence CA and SS Block (eds). Lea & Febiger: Philadelphia.

Spaulding EH. 1939. Studies on chemical sterilization of surgical instruments. *Surg Gyne Obstet* 69: 738–744.

The Population Council and the Program for Appropriate Technology in Health (PATH). 1989. *The Copper T 380A IUD: A Manual for Clinicians*, 2<sup>nd</sup> ed. PATH: Seattle, Washington.

Tietjen L, Bossemeyer D, and McIntosh N. 2003. *Infection Prevention: Guidelines for Healthcare Facilities with Limited Resources*. JHPIEGO: Baltimore.

Tietjen L, Cronin W, and N McIntosh. 1992. *Infection Prevention for Family Planning Service Programs: A Problem-Solving Reference Manual*. Essential Medical Information Systems, Inc.: Durant, Oklahoma.

Trieman K et al. 1995. IUDs: An update. *Population Reports Series B*, Dec XXIII (6). Johns Hopkins School of Public Health/Population Information Program: Baltimore.

Trussell J. 2004a. Contraceptive failure in the United States. *Contraception* 2004; 70: 89–96.

Trussell J. 2004b. Contraceptive efficacy. In: Hatcher RA, Trussell J, Stewart F et al. (Eds). 2004. *Contraceptive Technology* 18th ed. Ardent Media, Inc.: New York.

United Nations Development Programme, United Nations Population Fund, WHO, et al. 1997. Long-term reversible contraception. Twelve years of experience with the TCu380A and TCu220C. *Contraception* 56: 341–352.

Vessey MP, Yeates D, Flavel R, et al. Pelvic inflammatory disease and the intrauterine device: findings in a large cohort study. *Br Med J (Clin Res Ed)* 282: 855–857.

Weiss E and Moore K. 2003. An assessment of the quality of information available on the internet about the IUD and the potential impact on contraceptive choices. *Contraception* 68: 539–564.

World Health Organization (WHO). 2004a. *Medical Eligibility Criteria for Contraceptive Use*, 3rd ed. WHO: Geneva.

WHO. 2004b. *Selected practice recommendations for contraceptive use*. WHO: Geneva.

WHO. 2003. *Guidelines for the management of sexually transmitted infections*. WHO: Geneva.

WHO. 2000. *Improving Access to Quality Care in Family Planning: Medical Eligibility Criteria for Contraceptive Use*, 2nd ed. WHO: Geneva.

## **Bibliography**

WHO. 1989. *AIDS Series 2: Guidelines on Sterilization and High-Level Disinfection Methods Effective Against Human Immunodeficiency Virus (HIV)*, 2nd ed. WHO: Geneva.

WHO. 1987. *Mechanism of action, safety and efficacy of intrauterine devices*. Technical Report Series, no 753. WHO: Geneva.

WHO and Johns Hopkins Bloomberg School of Public Health (JHU)/Center for Communication Programs (CCP). 2006. *Family Planning: A Global Handbook for Providers*. The INFO Project, CCP: Baltimore.

Zetina-Lozano G. 1983. Menstrual bleeding expectations and short-term contraception discontinuation in Mexico. *Stud Fam Plann* 14: 127–133.

Zhang J et al. 1992. Risk factors for copper T IUD expulsion: An epidemiologic analysis. *Contraception* 46: 427–433.



# FHI's QUICK REFERENCE CHART

## for the WHO Medical Eligibility Criteria for Contraceptive Use

to initiate or continue the use of  
 Combined Oral Contraceptive (COC), Noristerat (NET-EN), Depo-Provera (DMPA), Copper Intrauterine Device (Cu-IUD)

		COC	NET-EN/ DMPA	Cu-IUD			COC	NET-EN/ DMPA	Cu-IUD
<b>Age</b>	Menarche to 39 years				<b>Known hyperlipidemias</b>				
	40 years or more				<b>Cancers</b>	Cervical			I C
	Menarche to 17 years					Endometrial			I C
	18 years to 45 years					Ovarian			I C
	More than 45 years				<b>Breast Disease</b>	Undiagnosed mass			
Less than 20 years				Family history of cancer					
20 years or more				Current cancer					
<b>Nulliparous</b>					<b>Uterine fibroids</b>				
<b>Breastfeeding</b>	Less than 6 weeks postpartum				<b>Endometriosis</b>				
	6 weeks to 6 months postpartum				<b>Trophoblast disease</b>				
	6 months postpartum or more				<b>Vaginal bleeding patterns</b>	Irregular without heavy bleeding			
<b>Smoking</b>	Age < 35 years					Heavy or prolonged, regular and irregular			
	Age ≥ 35 years, < 15 cigarettes/day					Unexplained bleeding			I C
	Age ≥ 35 years, ≥ 15 cigarettes/day				<b>Cirrhosis</b>	Mild			
<b>Hypertension</b>	History of hypertension where blood pressure CANNOT be evaluated					Severe			
	Controlled and CAN be evaluated				<b>Current symptomatic gall bladder disease</b>				
	Systolic 140 - 159 or Diastolic 90 - 99				<b>Cholestasis</b>	Related to the pregnancy			
	Systolic ≥ 160 or Diastolic ≥ 100					Related to oral contraceptives			
<b>Headaches</b>	Non-migrainous (mild or severe)	I C			<b>Hepatitis</b>	Active			
	Migraine without aura (age < 35 years)	I C	I C			Client is a carrier			
	Migraine without aura (age ≥ 35 years)	I C	I C		<b>Liver tumors</b>				
	Migraines with aura		I C			Current purulent cervicitis, chlamydia, gonorrhea			I C
	<b>History of deep venous thrombosis</b>					Vaginitis			
<b>Superficial thrombophlebitis</b>				<b>STIs/PID</b>	Pelvic inflammatory disease (PID)			I C	
<b>Complicated valvular heart disease</b>					Other STIs (excluding HIV/hepatitis)				
<b>Ischemic heart disease/stroke</b>					Increased risk of STIs				
<b>Diabetes</b>	Non-vascular disease				Increased individual risk of STIs			I C	
	Vascular disease or diabetes of > 20 years					<b>HIV</b>	High risk of HIV or HIV-infected		
<b>Malaria</b>				<b>AIDS</b>	No antiretroviral therapy (ARV), or not doing well on ARV therapy			I C	
<b>Non-pelvic tuberculosis</b>					Clinically well on ARV therapy				
<b>Thyroid disease</b>				<b>Use of:</b>	Griseofulvin				
<b>Iron deficiency anemia</b>					Rifampicin				
					Other antibiotics				

Category 1  There are no restrictions for use.

Category 3  Usually not recommended; clinical judgment and continuing access to clinical services are required for use.

Category 2  Generally use; some follow-up may be needed.

Category 4  The method should not be used.

I/C (Initiation/Continuation): A woman may fall into either one category or another, depending on whether she is *initiating* or *continuing* to use a method. For example, a client with current PID who wants to initiate IUD use would be considered as Category 4, and should not have an IUD inserted. However, if she develops PID while using the IUD, she would be considered as Category 2. This means she could generally continue using the IUD and be treated for PID with the IUD in place. Where I/C is not marked, a woman with that condition falls in the category indicated - whether or not she is initiating or continuing use of the method.

\*Postpartum IUD use by breastfeeding and non-breastfeeding women is Category 2 up to 48 hours postpartum, Category 3 from 48 hours to four weeks, and Category 1 four weeks and after.

Source: Adapted from *Improving Access to Quality Care in Family Planning: Medical Eligibility Criteria for Contraceptive Use*. Geneva: World Health Organization, Third edition, 2004.

Available: [http://www.who.int/reproductive-health/publications/MEC\\_3/index.htm](http://www.who.int/reproductive-health/publications/MEC_3/index.htm).

Printed with funds from USAID and developed by Family Health International.

© Family Health International, March 2004.



